

Schottky Barrier Rectifiers

Using the Schottky Barrier principle with a Molybdenum barrier metal. These state-of-the-art geometry features epitaxial construction with oxide passivation and metal overlay contact. Ideally suited for low voltage, high frequency rectification, or as free wheeling and polarity protection diodes.

- * Low Forward Voltage.
- * Low Switching noise.
- * High Current Capacity
- * Guarantee Reverse Avalanche.
- * Guard-Ring for Stress Protection.
- * Low Power Loss & High efficiency.
- * 125 °C Operating Junction Temperature
- * Low Stored Charge Majority Carrier Conduction.
- * Plastic Material used Carries Underwriters Laboratory Flammability Classification 94V-O

SCHOTTKY BARRIER RECTIFIERS

**16 AMPERES
30-60 VOLTS**

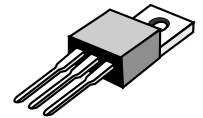

TO-220AB

MAXIMUM RATINGS

Characteristic	Symbol	S16C						Unit
		30	35	40	45	50	60	
Peak Repetitive Reverse Voltage Working Peak Reverse Voltage DC Blocking Voltage	V_{RRM} V_{RWM} V_R	30	35	40	45	50	60	V
RMS Reverse Voltage	$V_{R(RMS)}$	21	24	28	32	35	42	V
Average Rectifier Forward Current Total Device (Rated V_R), $T_c=100^\circ\text{C}$	$I_{F(AV)}$	8 16						A
Peak Repetitive Forward Current (Rate V_R , Square Wave, 20kHz)	I_{FRM}	16						A
Non-Repetitive Peak Surge Current (Surge applied at rate load conditions halfwave, single phase, 60Hz)	I_{FSM}	150						A
Operating and Storage Junction Temperature Range	T_J, T_{stg}	- 65 to + 125						°C

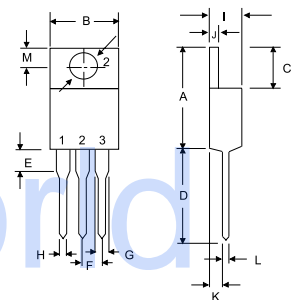

DIM	MILLIMETERS	
	MIN	MAX
A	14.68	15.32
B	9.78	10.42
C	6.01	6.52
D	13.06	14.62
E	3.57	4.07
F	2.42	2.66
G	1.12	1.36
H	0.72	0.96
I	4.22	4.98
J	1.14	1.36
K	2.20	2.97
L	0.33	0.55
M	2.48	2.98
O	3.70	3.90

ELECTRICAL CHARACTERISTICS

Characteristic	Symbol	S16C						Unit
		30	35	40	45	50	60	
Maximum Instantaneous Forward Voltage ($I_F=8.0$ Amp, $T_c = 25^\circ\text{C}$) ($I_F=8.0$ Amp, $T_c = 100^\circ\text{C}$)	V_F	0.55 0.48			0.70 0.57			V
Maximum Instantaneous Reverse Current (Rated DC Voltage, $T_c = 25^\circ\text{C}$) (Rated DC Voltage, $T_c = 100^\circ\text{C}$)	I_R	5.0 50						mA

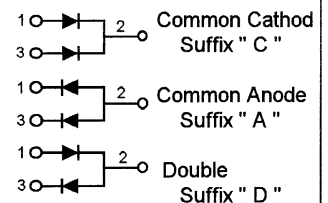

S16C30 thru S16C45

FIG-1 FORWARD CURRENT DERATING CURVE

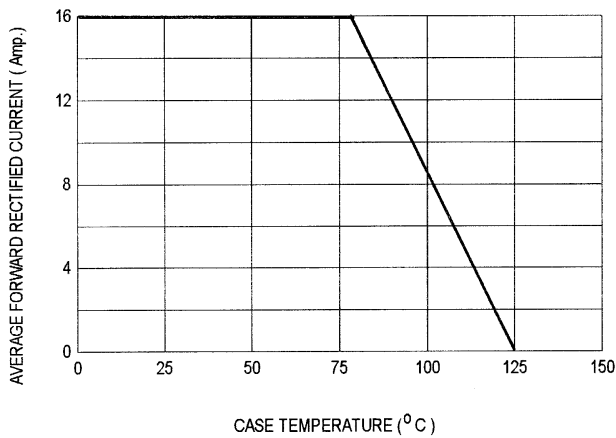

FIG-2 TYPICAL FORWARD CHARACTERISTICS

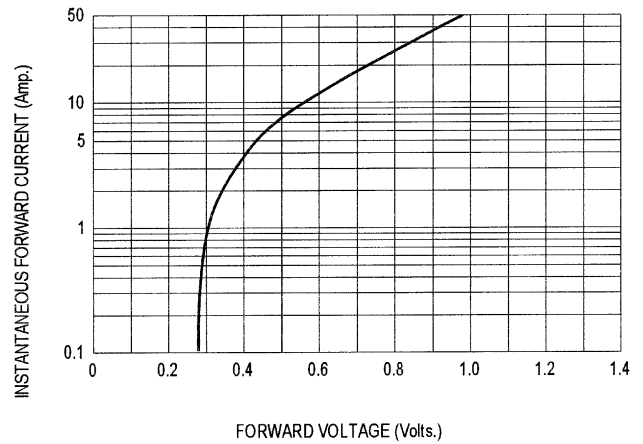

FIG-3 TYPICAL REVERSE CHARACTERISTICS

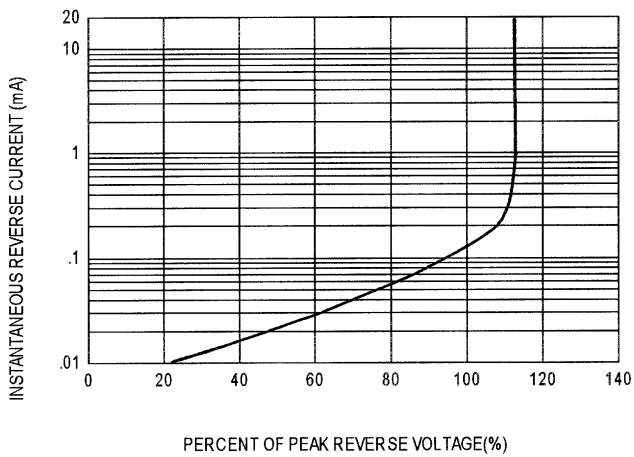

FIG-4 TYPICAL JUNCTION CAPACITANCE

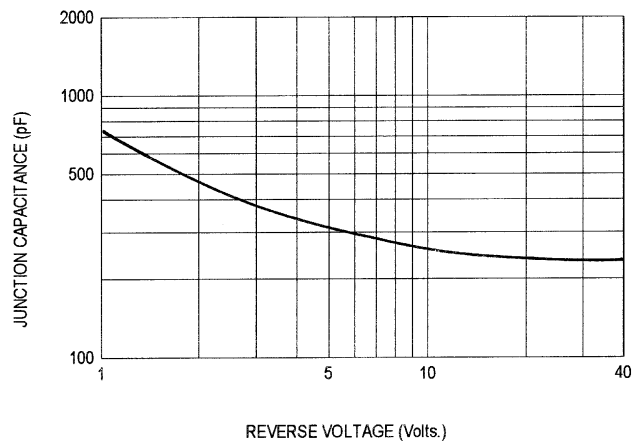
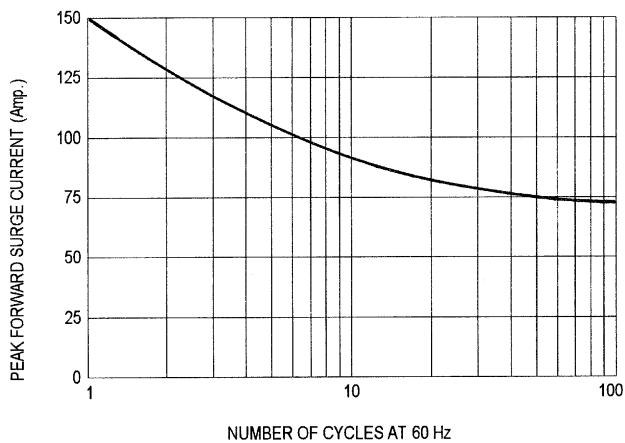

FIG-5 PEAK FORWARD SURGE CURRENT



S16C50 , S16C60

FIG-1 FORWARD CURRENT DERATING CURVE

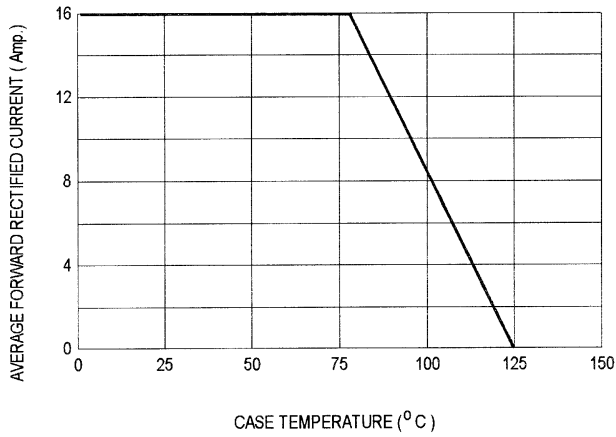

FIG-2 TYPICAL FORWARD CHARACTERISTICS

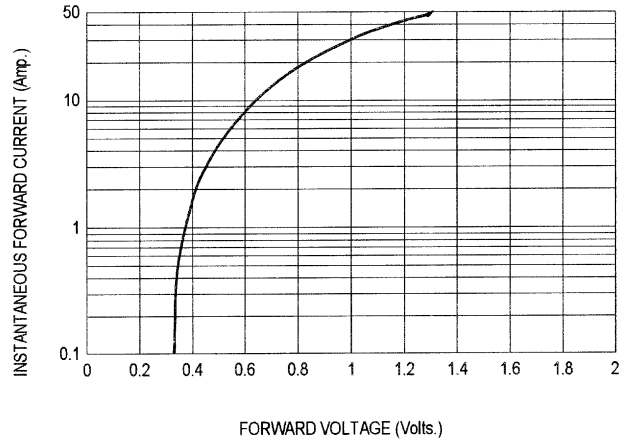

FIG-3 TYPICAL REVERSE CHARACTERISTICS

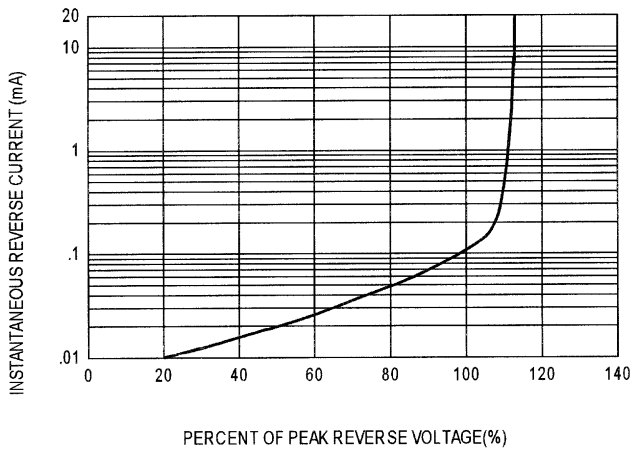

FIG-4 TYPICAL JUNCTION CAPACITANCE

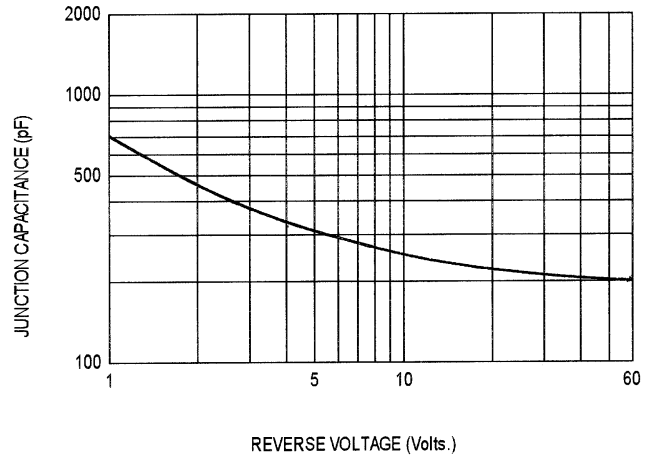

FIG-5 PEAK FORWARD SURGE CURRENT

