

## FEATURES

- **AM26LS32A Devices Meet or Exceed the Requirements of ANSI TIA/EIA-422-B, TIA/EIA-423-B, and ITU Recommendations V.10 and V.11**
- **AM26LS32A Devices Have  $\pm 7$ -V Common-Mode Range With  $\pm 200$ -mV Sensitivity**
- **AM26LS33A Devices Have  $\pm 15$ -V Common-Mode Range With  $\pm 500$ -mV Sensitivity**
- **Input Hysteresis . . . 50 mV Typical**
- **Operate From a Single 5-V Supply**
- **Low-Power Schottky Circuitry**
- **3-State Outputs**
- **Complementary Output-Enable Inputs**
- **Input Impedance . . . 12 k $\Omega$  Minimum**
- **Designed to Be Interchangeable With Advanced Micro Devices AM26LS32™ and AM26LS33™**

AM26LS32AC . . . D, N, NS, OR PW PACKAGE  
AM26LS32AI, AM26LS33AC . . . D, OR N PACKAGE  
AM26LS32AM, AM26LS33AM . . . J PACKAGE  
(TOP VIEW)

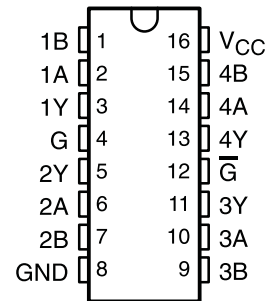

AM26LS32AM, AM26LS33AM . . . FK PACKAGE  
(TOP VIEW)

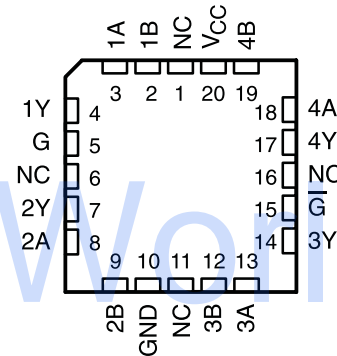

NC – No internal connection

## DESCRIPTION

The AM26LS32A and AM26LS33A devices are quadruple differential line receivers for balanced and unbalanced digital data transmission. The enable function is common to all four receivers and offers a choice of active-high or active-low input. The 3-state outputs permit connection directly to a bus-organized system. Fail-safe design ensures that, if the inputs are open, the outputs always are high.

Compared to the AM26LS32 and the AM26LS33, the AM26LS32A and AM26LS33A incorporate an additional stage of amplification to improve sensitivity. The input impedance has been increased, resulting in less loading of the bus line. The additional stage has increased propagation delay; however, this does not affect interchangeability in most applications.

The AM26LS32AC and AM26LS33AC are characterized for operation from 0°C to 70°C. The AM26LS32AI is characterized for operation from –40°C to 85°C. The AM26LS32AM and AM26LS33AM are characterized for operation over the full military temperature range of –55°C to 125°C.



Please be aware that an important notice concerning availability, standard warranty, and use in critical applications of Texas Instruments semiconductor products and disclaimers thereto appears at the end of this data sheet.

AM26LS32, AM26LS33 are trademarks of Advanced Micro Devices, Inc..

**AM26LS32AC, AM26LS32AI, AM26LS33AC  
AM26LS32AM, AM26LS33AM  
QUADRUPLE DIFFERENTIAL LINE RECEIVERS**

SLLS115E—OCTOBER 1980—REVISED OCTOBER 2007

**FUNCTION TABLE  
Each Receiver**

| DIFFERENTIAL<br>A-B                | ENABLES |           | OUTPUT<br>Y |
|------------------------------------|---------|-----------|-------------|
|                                    | G       | $\bar{G}$ |             |
| $V_{ID} \geq V_{IT+}$              | H       | X         | H           |
|                                    | X       | L         | H           |
| $V_{IT-} \leq V_{ID} \leq V_{IT+}$ | H       | X         | ?           |
|                                    | X       | L         | ?           |
| $V_{ID} \leq V_{IT-}$              | H       | X         | L           |
|                                    | X       | L         | L           |
| X                                  | L       | H         | Z           |
| Open                               | H       | X         | H           |
|                                    | X       | L         | H           |

**LOGIC DIAGRAM (POSITIVE LOGIC)**



Pin numbers are for D, N, NS, or PW packages only.

SCHEMATICS OF INPUTS AND OUTPUTS

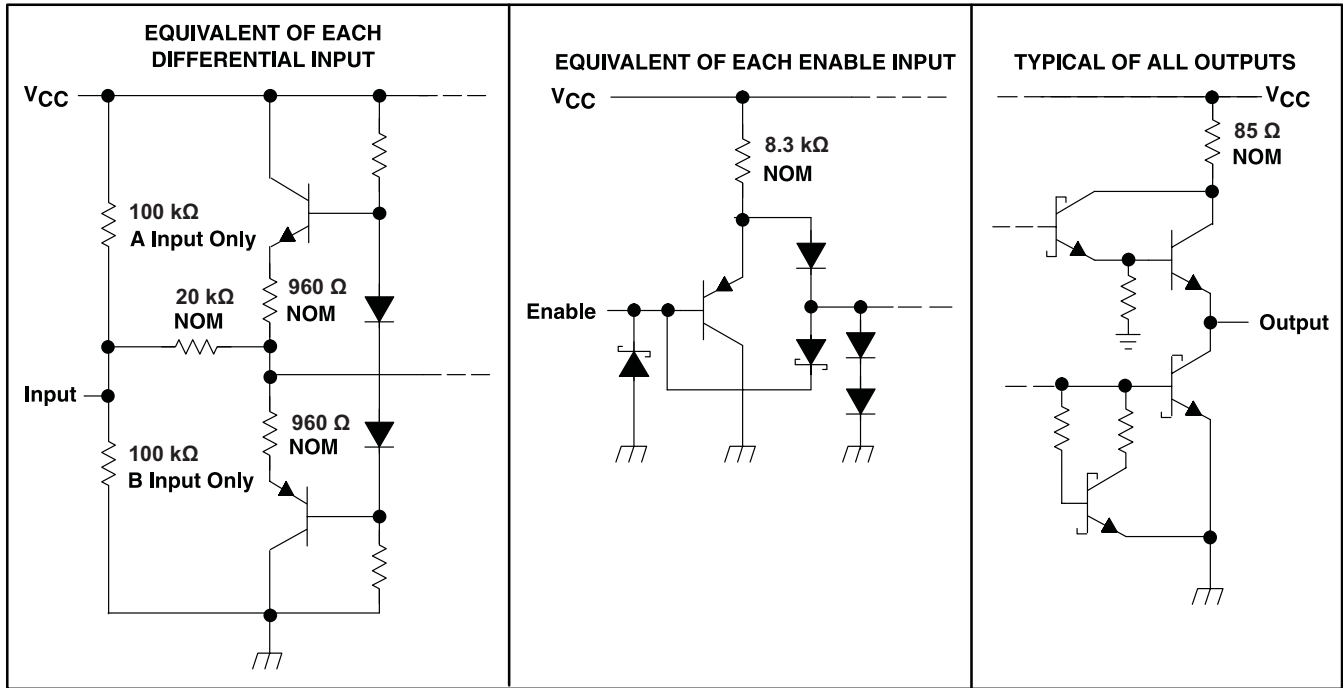

ABSOLUTE MAXIMUM RATINGS<sup>(1)</sup>

over operating free-air temperature range (unless otherwise noted)

|               |  | MIN                           | MAX      | UNIT |
|---------------|--|-------------------------------|----------|------|
| $V_{CC}$      | Supply voltage <sup>(2)</sup>                                |                               | 7        | V    |
| $V_I$         | Input voltage  | Any differential input        | $\pm 25$ | V    |
|               |  | Other inputs                  | 7        |      |
| $V_{ID}$      | Differential input voltage <sup>(3)</sup>                    |                               | $\pm 25$ | V    |
|               | Continuous total power dissipation                           | See Dissipation Ratings Table |          |      |
| $\theta_{JA}$ | Package thermal impedance <sup>(4)</sup>                     | D package                     | 73       | °C/W |
|               |  | N package                     | 67       |      |
|               |  | NS package                    | 64       |      |
|               |  | PW package                    | 108      |      |
| $T_C$         | Case temperature for 60 seconds                              | FK package                    | 260      | °C   |
|               | Lead temperature 1.6 mm (1/16 inch) from case for 10 seconds | D or N package                | 260      | °C   |
|               | Lead temperature 1.6 mm (1/16 inch) from case for 60 seconds | J package                     | 300      | °C   |
| $T_{stg}$     | Storage temperature range                                    | -65                           | 150      | °C   |

- (1) Stresses beyond those listed under "absolute maximum ratings" may cause permanent damage to the device. These are stress ratings only, and functional operation of the device at these or any other conditions beyond those indicated under "recommended operating conditions" is not implied. Exposure to absolute-maximum-rated conditions for extended periods may affect device reliability.
- (2) All voltage values, except differential voltages, are with respect to the network ground terminal.
- (3) Differential voltage values are at the noninverting (A) input terminals with respect to the inverting (B) input terminals.
- (4) The package thermal impedance is calculated in accordance with JESD 51-7.

**AM26LS32AC, AM26LS32AI, AM26LS33AC  
AM26LS32AM, AM26LS33AM  
QUADRUPLE DIFFERENTIAL LINE RECEIVERS**

SLLS115E—OCTOBER 1980—REVISED OCTOBER 2007

**DISSIPATION RATINGS**

| PACKAGE | T <sub>A</sub> ≤ 25°C<br>POWER RATING | DERATION<br>FACTOR<br>ABOVE T <sub>A</sub> = 25°C | T <sub>A</sub> = 70°C<br>POWER RATING | T <sub>A</sub> = 125°C<br>POWER RATING |
|---------|---------------------------------------|---|---------------------------------------|--|
| FK      | 1375 mW                               | 11.0 mW/°C  | 880 mW                                | 275 mW                                 |
| J       | 1375 mW                               | 11.0 mW/°C  | 880 mW                                | 275 mW                                 |

**RECOMMENDED OPERATING CONDITIONS**

|                 |                                | MIN                                   | NOM | MAX  | UNIT |
|-----------------|--------------------------------|---------------------------------------|-----|------|------|
| V <sub>CC</sub> | Supply voltage                 | AM26LS32AC, AM26LS32AI,<br>AM26LS33AC |     |      | V    |
|                 |                                | 4.75                                  | 5   | 5.25 |      |
|                 |                                | AM26LS32AM, AM26LS33AM                |     |      |      |
|                 |                                | 4.5                                   | 5   | 5.5  |      |
| V <sub>IH</sub> | High-level input voltage       | 2                                     |     |      | V    |
| V <sub>IL</sub> | Low-level input voltage        |                                       |     | 0.8  | V    |
| V <sub>IC</sub> | Common-mode input voltage      | AM26LS32A                             |     |      | V    |
|                 |                                |                                       |     | ±7   |      |
|                 |                                | AM26LS33A                             |     |      |      |
|                 |                                |                                       |     | ±15  |      |
| I <sub>OH</sub> | High-level output current      |                                       |     | -440 | μA   |
| I <sub>OL</sub> | Low-level output current       |                                       |     | 8    | mA   |
| T <sub>A</sub>  | Operating free-air temperature | AM26LS32AC, AM26LS33AC                |     |      | °C   |
|                 |                                | 0                                     |     | 70   |      |
|                 |                                | AM26LS32AI                            |     |      |      |
|                 |                                | -40                                   |     | 85   |      |
|                 |                                | AM26LS32AM, AM26LS33AM                |     |      |      |
|                 |                                | -55                                   |     | 125  |      |

**ELECTRICAL CHARACTERISTICS**

over recommended ranges of V<sub>CC</sub>, V<sub>IC</sub>, and operating free-air temperature (unless otherwise noted)

| PARAMETER          |   | TEST CONDITIONS   |  | MIN | TYP <sup>(1)</sup> | MAX                 | UNIT |
|--------------------|---|---|--|-----|--------------------|---------------------|------|
| V <sub>IT+</sub>   | Positive-going input threshold voltage                    | V <sub>O</sub> = V <sub>OHmin</sub> , I <sub>OH</sub> = -440 μA                                       | AM26LS32A                                |     |                    | 0.2                 | V    |
|                    |   |   | AM26LS33A                                |     |                    | 0.5                 |      |
| V <sub>IT-</sub>   | Negative-going input threshold voltage                    | V <sub>O</sub> = 0.45 V, I <sub>OL</sub> = 8 mA   | AM26LS32A                                |     |                    | -0.2 <sup>(2)</sup> | V    |
|                    |   |   | AM26LS33A                                |     |                    | -0.5 <sup>(2)</sup> |      |
| V <sub>hys</sub>   | Hysteresis voltage (V <sub>IT+</sub> - V <sub>IT-</sub> ) |   |  |     | 50                 |                     | mV   |
| V <sub>IK</sub>    | Enable-input clamp voltage                                | V <sub>CC</sub> = MIN,  | I <sub>I</sub> = -18 mA                  |     |                    | -1.5                | V    |
| V <sub>OH</sub>    | High-level output voltage                                 | V <sub>CC</sub> = MIN, V <sub>ID</sub> = 1 V,<br>V <sub>I(G)</sub> = 0.8 V, I <sub>OH</sub> = -440 μA | AM26LS32AC,<br>AM26LS33AC                |     |                    | 2.7                 | V    |
|                    |   |   | AM26LS32AM,<br>AM26LS32AI,<br>AM26LS33AM |     |                    | 2.5                 |      |
| V <sub>OL</sub>    | Low-level output voltage                                  | V <sub>CC</sub> = MIN, V <sub>ID</sub> = -1 V,<br>V <sub>I(G)</sub> = 0.8 V                           | I <sub>OL</sub> = 4 mA                   |     |                    | 0.4                 | V    |
|                    |   |   | I <sub>OL</sub> = 8 mA                   |     |                    | 0.45                |      |
| I <sub>OZ</sub>    | Off-state (high-impedance state) output current           | V <sub>CC</sub> = MAX   | V <sub>O</sub> = 2.4 V                   |     |                    | 20                  | μA   |
|                    |   |   | V <sub>O</sub> = 0.4 V                   |     |                    | -20                 |      |
| I <sub>I</sub>     | Line input current  | V <sub>I</sub> = 15 V,  | Other input at -10 V to 15 V             |     |                    | 1.2                 | mA   |
|                    |   | V <sub>I</sub> = -15 V,   | Other input at -15 V to 10 V             |     |                    | -1.7                |      |
| I <sub>I(EN)</sub> | Enable input current                                      | V <sub>I</sub> = 5.5 V  |  |     |                    | 100                 | μA   |
| I <sub>H</sub>     | High-level enable current                                 | V <sub>I</sub> = 2.7 V  |  |     |                    | 20                  | μA   |

(1) All typical values are at V<sub>CC</sub> = 5 V, T<sub>A</sub> = 25°C, and V<sub>IC</sub> = 0.

(2) The algebraic convention, in which the less positive (more negative) limit is designated as minimum, is used in this data sheet for threshold levels only.

**ELECTRICAL CHARACTERISTICS (continued)**

 over recommended ranges of  $V_{CC}$ ,  $V_{IC}$ , and operating free-air temperature (unless otherwise noted)

| PARAMETER |   | TEST CONDITIONS  | MIN | TYP <sup>(1)</sup> | MAX   | UNIT       |
|-----------|---|--|-----|--------------------|-------|------------|
| $I_L$     | Low-level enable current                    | $V_I = 0.4\text{ V}$   |     |                    | –0.36 | mA         |
| $r_i$     | Input resistance                            | $V_{IC} = -15\text{ V to }15\text{ V}$ ,<br>One input to ac ground | 12  | 15                 |       | k $\Omega$ |
| $I_{OS}$  | Short-circuit output current <sup>(3)</sup> | $V_{CC} = \text{MAX}$  | –15 |                    | –85   | mA         |
| $I_{CC}$  | Supply current                              | $V_{CC} = \text{MAX}$ ,<br>All outputs disabled                    |     | 52                 | 70    | mA         |

(3) Not more than one output should be shorted to ground at a time, and duration of the short circuit should not exceed one second.

**SWITCHING CHARACTERISTICS**
 $V_{CC} = 5\text{ V}$ ,  $T_A = 25^\circ\text{C}$ 

| PARAMETER |  | TEST CONDITIONS  | MIN | TYP <sup>(1)</sup> | MAX | UNIT |
|-----------|--|--|-----|--------------------|-----|------|
| $t_{PLH}$ | Propagation delay time, low-to-high-level output | $C_L = 15\text{ pF}$ ,<br>See <a href="#">Figure 1</a> |     | 20                 | 35  | ns   |
| $t_{PHL}$ | Propagation delay time, high-to-low-level output |  |     | 22                 | 35  |      |
| $t_{PZH}$ | Output enable time to high level                 | $C_L = 15\text{ pF}$ ,<br>See <a href="#">Figure 1</a> |     | 17                 | 22  | ns   |
| $t_{PZL}$ | Output enable time to low level                  |  |     | 20                 | 25  |      |
| $t_{PHZ}$ | Output disable time from high level              | $C_L = 15\text{ pF}$ ,<br>See <a href="#">Figure 1</a> |     | 21                 | 30  | ns   |
| $t_{PLZ}$ | Output disable time from low level               |  |     | 30                 | 40  |      |

 (1) All typical values are at  $V_{CC} = 5\text{ V}$ ,  $T_A = 25^\circ\text{C}$ , and  $V_{IC} = 0$ .

PARAMETER MEASUREMENT INFORMATION

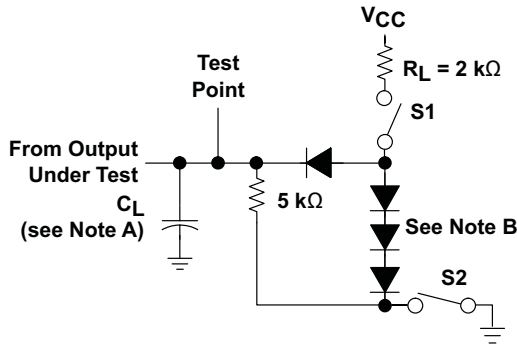

TEST CIRCUIT

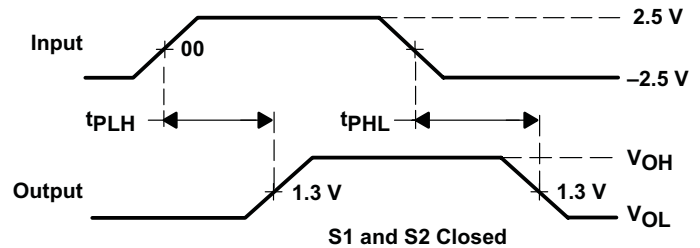

VOLTAGE WAVEFORMS FOR  $t_{PLH}$ ,  $t_{PHL}$

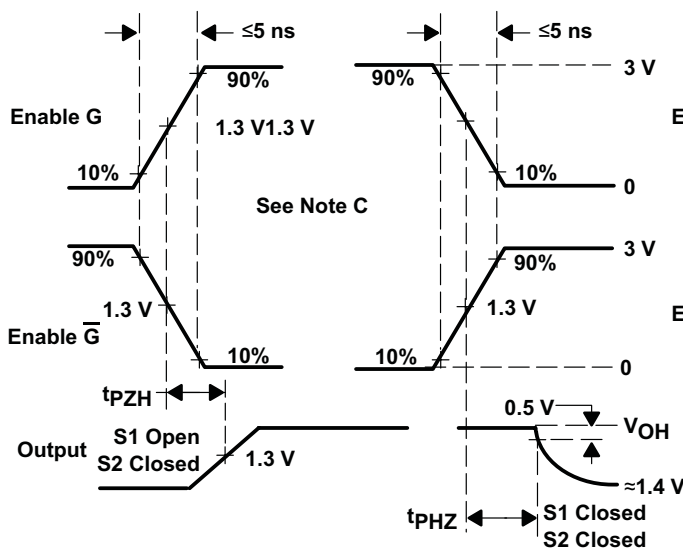

VOLTAGE WAVEFORMS FOR  $t_{PHZ}$ ,  $t_{PZH}$

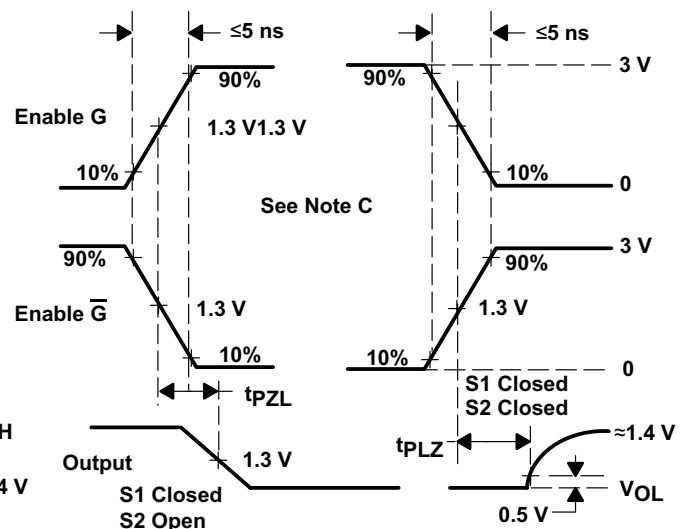

VOLTAGE WAVEFORMS FOR  $t_{PLZ}$ ,  $t_{PZL}$

- NOTES: A.  $C_L$  includes probe and jig capacitance.  
 B. All diodes are 1N3064 or equivalent.  
 C. Enable G is tested with  $\bar{G}$  high;  $\bar{G}$  is tested with G low.

Figure 1. Test Circuit and Voltage Waveforms

TYPICAL CHARACTERISTICS

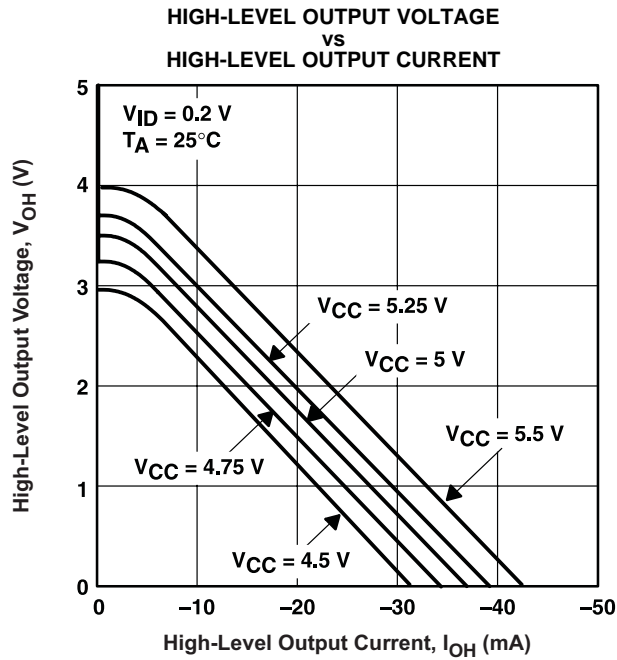

†  $V_{CC} = 5.5\text{ V}$  and  $V_{CC} = 4.5\text{ V}$  applies to M-suffix devices only.

Figure 2.



Figure 3.

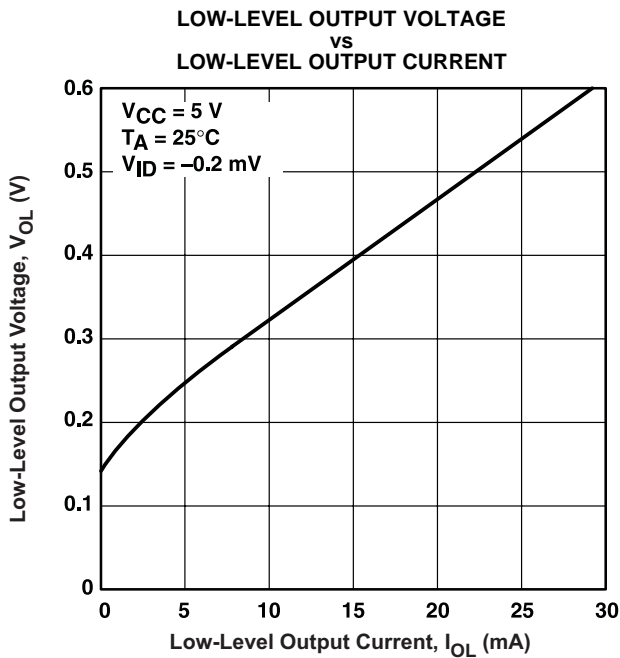

Figure 4.

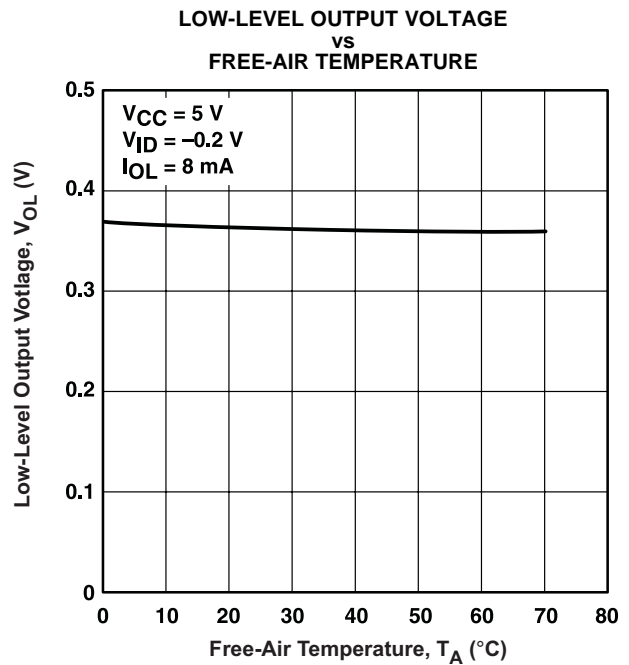

Figure 5.

TYPICAL CHARACTERISTICS (continued)



Figure 6.



Figure 7.

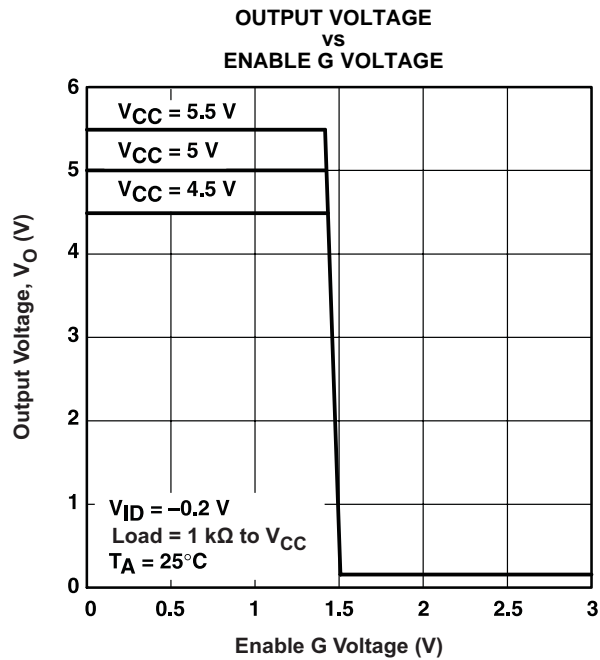

Figure 8.

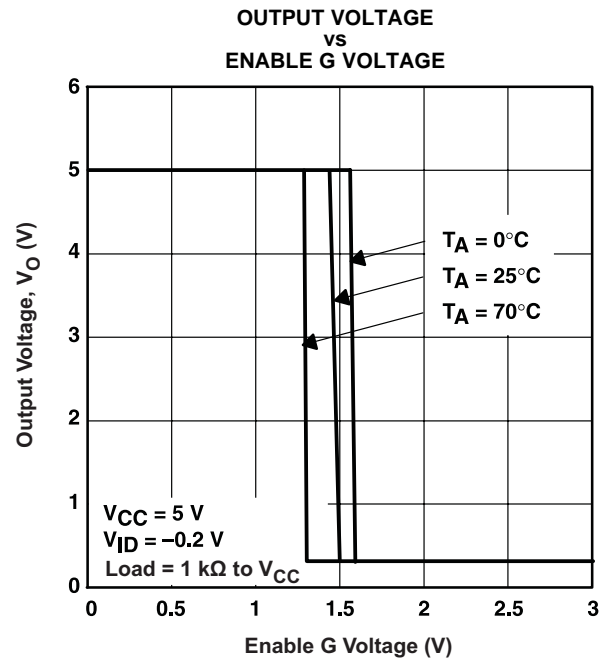

Figure 9.



TYPICAL CHARACTERISTICS (continued)

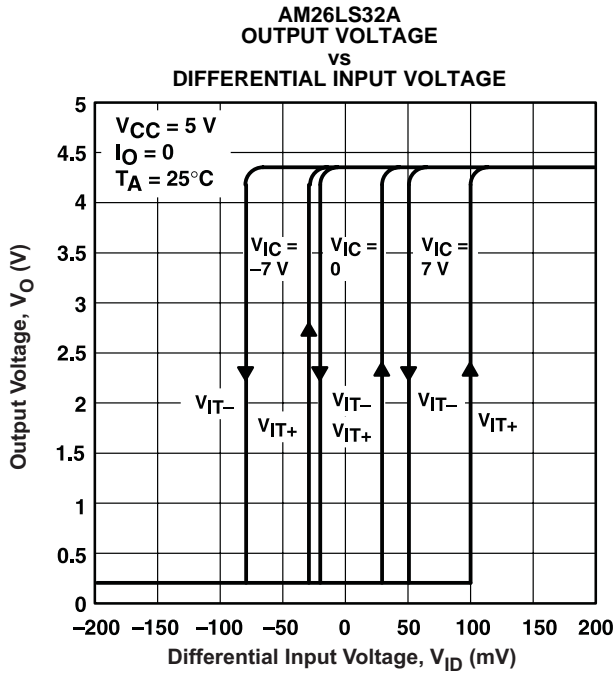

Figure 10.

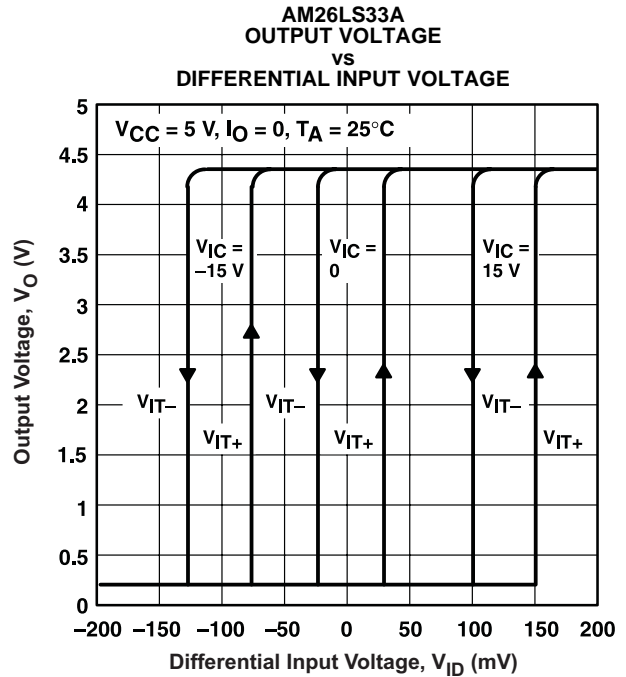
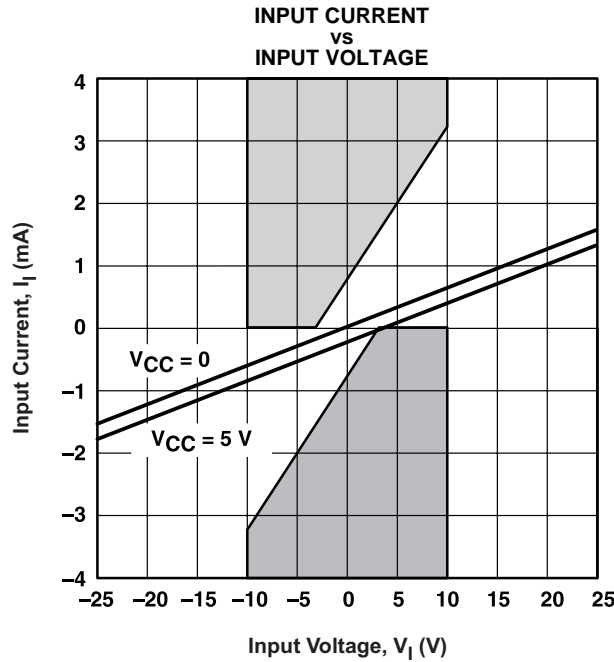

Figure 11.



The unshaded area shows requirements of paragraph 4.2.1 of ANSI Standards EIA/TIA-422-B and EIA/TIA-423-B.

Figure 12.

### APPLICATION INFORMATION

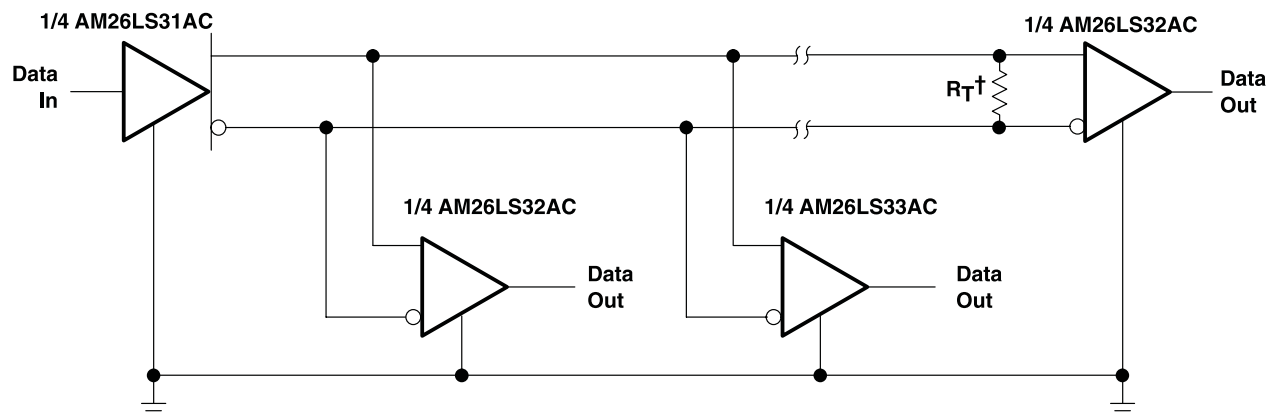

†  $R_T$  equals the characteristic impedance of the line.

Figure 13. Circuit with Multiple Receivers

**PACKAGING INFORMATION**

| Orderable Device | Status <sup>(1)</sup> | Package Type | Package Drawing | Pins | Package Qty | Eco Plan <sup>(2)</sup>    | Lead/<br>Ball Finish | MSL Peak Temp <sup>(3)</sup> | Samples<br>(Requires Login) |
|------------------|-----------------------|--------------|-----------------|------|-------------|----------------------------|----------------------|------------------------------|-----------------------------|
| 5962-7802003M2A  | ACTIVE                | LCCC         | FK              | 20   | 1           | TBD                        | Call TI              | Call TI                      |                             |
| 5962-7802003MEA  | ACTIVE                | CDIP         | J               | 16   | 1           | TBD                        | Call TI              | Call TI                      |                             |
| 5962-7802003MFA  | ACTIVE                | CFP          | W               | 16   | 1           | TBD                        | Call TI              | Call TI                      |                             |
| 5962-7802004M2A  | ACTIVE                | LCCC         | FK              | 20   | 1           | TBD                        | Call TI              | Call TI                      |                             |
| 5962-7802004MEA  | ACTIVE                | CDIP         | J               | 16   | 1           | TBD                        | Call TI              | Call TI                      |                             |
| 5962-7802004MFA  | ACTIVE                | CFP          | W               | 16   | 1           | TBD                        | Call TI              | Call TI                      |                             |
| AM26LS32ACD      | ACTIVE                | SOIC         | D               | 16   | 40          | Green (RoHS<br>& no Sb/Br) | CU NIPDAU            | Level-1-260C-UNLIM           |                             |
| AM26LS32ACDE4    | ACTIVE                | SOIC         | D               | 16   | 40          | Green (RoHS<br>& no Sb/Br) | CU NIPDAU            | Level-1-260C-UNLIM           |                             |
| AM26LS32ACDG4    | ACTIVE                | SOIC         | D               | 16   | 40          | Green (RoHS<br>& no Sb/Br) | CU NIPDAU            | Level-1-260C-UNLIM           |                             |
| AM26LS32ACDR     | ACTIVE                | SOIC         | D               | 16   | 2500        | Green (RoHS<br>& no Sb/Br) | CU NIPDAU            | Level-1-260C-UNLIM           |                             |
| AM26LS32ACDRE4   | ACTIVE                | SOIC         | D               | 16   | 2500        | Green (RoHS<br>& no Sb/Br) | CU NIPDAU            | Level-1-260C-UNLIM           |                             |
| AM26LS32ACDRG4   | ACTIVE                | SOIC         | D               | 16   | 2500        | Green (RoHS<br>& no Sb/Br) | CU NIPDAU            | Level-1-260C-UNLIM           |                             |
| AM26LS32ACN      | ACTIVE                | PDIP         | N               | 16   | 25          | Pb-Free (RoHS)             | CU NIPDAU            | N / A for Pkg Type           |                             |
| AM26LS32ACNE4    | ACTIVE                | PDIP         | N               | 16   | 25          | Pb-Free (RoHS)             | CU NIPDAU            | N / A for Pkg Type           |                             |
| AM26LS32ACNSR    | ACTIVE                | SO           | NS              | 16   | 2000        | Green (RoHS<br>& no Sb/Br) | CU NIPDAU            | Level-1-260C-UNLIM           |                             |
| AM26LS32ACNSRG4  | ACTIVE                | SO           | NS              | 16   | 2000        | Green (RoHS<br>& no Sb/Br) | CU NIPDAU            | Level-1-260C-UNLIM           |                             |
| AM26LS32ACPW     | ACTIVE                | TSSOP        | PW              | 16   | 90          | Green (RoHS<br>& no Sb/Br) | CU NIPDAU            | Level-1-260C-UNLIM           |                             |
| AM26LS32ACPWE4   | ACTIVE                | TSSOP        | PW              | 16   | 90          | Green (RoHS<br>& no Sb/Br) | CU NIPDAU            | Level-1-260C-UNLIM           |                             |
| AM26LS32ACPWG4   | ACTIVE                | TSSOP        | PW              | 16   | 90          | Green (RoHS<br>& no Sb/Br) | CU NIPDAU            | Level-1-260C-UNLIM           |                             |
| AM26LS32ACPWR    | ACTIVE                | TSSOP        | PW              | 16   | 2000        | Green (RoHS<br>& no Sb/Br) | CU NIPDAU            | Level-1-260C-UNLIM           |                             |

| Orderable Device | Status <sup>(1)</sup> | Package Type | Package Drawing | Pins | Package Qty | Eco Plan <sup>(2)</sup> | Lead/<br>Ball Finish | MSL Peak Temp <sup>(3)</sup> | Samples<br>(Requires Login) |
|------------------|-----------------------|--------------|-----------------|------|-------------|-------------------------|----------------------|------------------------------|-----------------------------|
| AM26LS32ACPWRE4  | ACTIVE                | TSSOP        | PW              | 16   | 2000        | Green (RoHS & no Sb/Br) | CU NIPDAU            | Level-1-260C-UNLIM           |                             |
| AM26LS32ACPWRG4  | ACTIVE                | TSSOP        | PW              | 16   | 2000        | Green (RoHS & no Sb/Br) | CU NIPDAU            | Level-1-260C-UNLIM           |                             |
| AM26LS32AID      | ACTIVE                | SOIC         | D               | 16   | 40          | Green (RoHS & no Sb/Br) | CU NIPDAU            | Level-1-260C-UNLIM           |                             |
| AM26LS32AIDE4    | ACTIVE                | SOIC         | D               | 16   | 40          | Green (RoHS & no Sb/Br) | CU NIPDAU            | Level-1-260C-UNLIM           |                             |
| AM26LS32AIDG4    | ACTIVE                | SOIC         | D               | 16   | 40          | Green (RoHS & no Sb/Br) | CU NIPDAU            | Level-1-260C-UNLIM           |                             |
| AM26LS32AIDR     | ACTIVE                | SOIC         | D               | 16   | 2500        | Green (RoHS & no Sb/Br) | CU NIPDAU            | Level-1-260C-UNLIM           |                             |
| AM26LS32AIDRE4   | ACTIVE                | SOIC         | D               | 16   | 2500        | Green (RoHS & no Sb/Br) | CU NIPDAU            | Level-1-260C-UNLIM           |                             |
| AM26LS32AIDRG4   | ACTIVE                | SOIC         | D               | 16   | 2500        | Green (RoHS & no Sb/Br) | CU NIPDAU            | Level-1-260C-UNLIM           |                             |
| AM26LS32AIN      | ACTIVE                | PDIP         | N               | 16   | 25          | Pb-Free (RoHS)          | CU NIPDAU            | N / A for Pkg Type           |                             |
| AM26LS32AINE4    | ACTIVE                | PDIP         | N               | 16   | 25          | Pb-Free (RoHS)          | CU NIPDAU            | N / A for Pkg Type           |                             |
| AM26LS32AMFKB    | ACTIVE                | LCCC         | FK              | 20   | 1           | TBD                     | POST-PLATE           | N / A for Pkg Type           |                             |
| AM26LS32AMJ      | ACTIVE                | CDIP         | J               | 16   | 1           | TBD                     | A42                  | N / A for Pkg Type           |                             |
| AM26LS32AMJB     | ACTIVE                | CDIP         | J               | 16   | 1           | TBD                     | A42                  | N / A for Pkg Type           |                             |
| AM26LS32AMWB     | ACTIVE                | CFP          | W               | 16   | 1           | TBD                     | A42                  | N / A for Pkg Type           |                             |
| AM26LS33ACD      | ACTIVE                | SOIC         | D               | 16   | 40          | Green (RoHS & no Sb/Br) | CU NIPDAU            | Level-1-260C-UNLIM           |                             |
| AM26LS33ACDE4    | ACTIVE                | SOIC         | D               | 16   | 40          | Green (RoHS & no Sb/Br) | CU NIPDAU            | Level-1-260C-UNLIM           |                             |
| AM26LS33ACDG4    | ACTIVE                | SOIC         | D               | 16   | 40          | Green (RoHS & no Sb/Br) | CU NIPDAU            | Level-1-260C-UNLIM           |                             |
| AM26LS33ACDR     | ACTIVE                | SOIC         | D               | 16   | 2500        | Green (RoHS & no Sb/Br) | CU NIPDAU            | Level-1-260C-UNLIM           |                             |
| AM26LS33ACDRE4   | ACTIVE                | SOIC         | D               | 16   | 2500        | Green (RoHS & no Sb/Br) | CU NIPDAU            | Level-1-260C-UNLIM           |                             |
| AM26LS33ACDRG4   | ACTIVE                | SOIC         | D               | 16   | 2500        | Green (RoHS & no Sb/Br) | CU NIPDAU            | Level-1-260C-UNLIM           |                             |
| AM26LS33ACN      | ACTIVE                | PDIP         | N               | 16   | 25          | Pb-Free (RoHS)          | CU NIPDAU            | N / A for Pkg Type           |                             |

| Orderable Device | Status <sup>(1)</sup> | Package Type | Package Drawing | Pins | Package Qty | Eco Plan <sup>(2)</sup> | Lead/<br>Ball Finish | MSL Peak Temp <sup>(3)</sup> | Samples<br>(Requires Login) |
|------------------|-----------------------|--------------|-----------------|------|-------------|-------------------------|----------------------|------------------------------|-----------------------------|
| AM26LS33ACNE4    | ACTIVE                | PDIP         | N               | 16   | 25          | Pb-Free (RoHS)          | CU NIPDAU            | N / A for Pkg Type           |                             |
| AM26LS33AMFKB    | ACTIVE                | LCCC         | FK              | 20   | 1           | TBD                     | POST-PLATE           | N / A for Pkg Type           |                             |
| AM26LS33AMJ      | ACTIVE                | CDIP         | J               | 16   | 1           | TBD                     | A42                  | N / A for Pkg Type           |                             |
| AM26LS33AMJB     | ACTIVE                | CDIP         | J               | 16   | 1           | TBD                     | A42                  | N / A for Pkg Type           |                             |
| AM26LS33AMWB     | ACTIVE                | CFP          | W               | 16   | 1           | TBD                     | A42                  | N / A for Pkg Type           |                             |

<sup>(1)</sup> The marketing status values are defined as follows:

**ACTIVE:** Product device recommended for new designs.

**LIFEBUY:** TI has announced that the device will be discontinued, and a lifetime-buy period is in effect.

**NRND:** Not recommended for new designs. Device is in production to support existing customers, but TI does not recommend using this part in a new design.

**PREVIEW:** Device has been announced but is not in production. Samples may or may not be available.

**OBSOLETE:** TI has discontinued the production of the device.

<sup>(2)</sup> Eco Plan - The planned eco-friendly classification: Pb-Free (RoHS), Pb-Free (RoHS Exempt), or Green (RoHS & no Sb/Br) - please check <http://www.ti.com/productcontent> for the latest availability information and additional product content details.

**TBD:** The Pb-Free/Green conversion plan has not been defined.

**Pb-Free (RoHS):** TI's terms "Lead-Free" or "Pb-Free" mean semiconductor products that are compatible with the current RoHS requirements for all 6 substances, including the requirement that lead not exceed 0.1% by weight in homogeneous materials. Where designed to be soldered at high temperatures, TI Pb-Free products are suitable for use in specified lead-free processes.

**Pb-Free (RoHS Exempt):** This component has a RoHS exemption for either 1) lead-based flip-chip solder bumps used between the die and package, or 2) lead-based die adhesive used between the die and leadframe. The component is otherwise considered Pb-Free (RoHS compatible) as defined above.

**Green (RoHS & no Sb/Br):** TI defines "Green" to mean Pb-Free (RoHS compatible), and free of Bromine (Br) and Antimony (Sb) based flame retardants (Br or Sb do not exceed 0.1% by weight in homogeneous material)

<sup>(3)</sup> MSL, Peak Temp. -- The Moisture Sensitivity Level rating according to the JEDEC industry standard classifications, and peak solder temperature.

**Important Information and Disclaimer:** The information provided on this page represents TI's knowledge and belief as of the date that it is provided. TI bases its knowledge and belief on information provided by third parties, and makes no representation or warranty as to the accuracy of such information. Efforts are underway to better integrate information from third parties. TI has taken and continues to take reasonable steps to provide representative and accurate information but may not have conducted destructive testing or chemical analysis on incoming materials and chemicals. TI and TI suppliers consider certain information to be proprietary, and thus CAS numbers and other limited information may not be available for release.

In no event shall TI's liability arising out of such information exceed the total purchase price of the TI part(s) at issue in this document sold by TI to Customer on an annual basis.

**OTHER QUALIFIED VERSIONS OF AM26LS32A, AM26LS32AM, AM26LS33A, AM26LS33AM :**

● Catalog: [AM26LS32A](#), [AM26LS33A](#)

● Enhanced Product: [AM26LS32AM-EP](#)

- Military: [AM26LS32AM](#), [AM26LS33AM](#)
- Space: [AM26LS33A-SP](#), [AM26LS33A-SP](#)

NOTE: Qualified Version Definitions:

- Catalog - TI's standard catalog product
- Enhanced Product - Supports Defense, Aerospace and Medical Applications
- Military - QML certified for Military and Defense Applications
- Space - Radiation tolerant, ceramic packaging and qualified for use in Space-based application

**TAPE AND REEL INFORMATION**
**REEL DIMENSIONS**

**TAPE DIMENSIONS**

|    |   |
|----|---|
| A0 | Dimension designed to accommodate the component width     |
| B0 | Dimension designed to accommodate the component length    |
| K0 | Dimension designed to accommodate the component thickness |
| W  | Overall width of the carrier tape                         |
| P1 | Pitch between successive cavity centers                   |

**TAPE AND REEL INFORMATION**

\*All dimensions are nominal

| Device        | Package Type | Package Drawing | Pins | SPQ  | Reel Diameter (mm) | Reel Width W1 (mm) | A0 (mm) | B0 (mm) | K0 (mm) | P1 (mm) | W (mm) | Pin1 Quadrant |
|---------------|--------------|-----------------|------|------|--------------------|--------------------|---------|---------|---------|---------|--------|---------------|
| AM26LS32ACDR  | SOIC         | D               | 16   | 2500 | 330.0              | 16.4               | 6.5     | 10.3    | 2.1     | 8.0     | 16.0   | Q1            |
| AM26LS32ACDR  | SOIC         | D               | 16   | 2500 | 330.0              | 16.4               | 6.5     | 10.3    | 2.1     | 8.0     | 16.0   | Q1            |
| AM26LS32ACNSR | SO           | NS              | 16   | 2000 | 330.0              | 16.4               | 8.2     | 10.5    | 2.5     | 12.0    | 16.0   | Q1            |
| AM26LS32ACPWR | TSSOP        | PW              | 16   | 2000 | 330.0              | 12.4               | 6.9     | 5.6     | 1.6     | 8.0     | 12.0   | Q1            |
| AM26LS32AIDR  | SOIC         | D               | 16   | 2500 | 330.0              | 16.4               | 6.5     | 10.3    | 2.1     | 8.0     | 16.0   | Q1            |
| AM26LS33ACDR  | SOIC         | D               | 16   | 2500 | 330.0              | 16.4               | 6.5     | 10.3    | 2.1     | 8.0     | 16.0   | Q1            |

**TAPE AND REEL BOX DIMENSIONS**

\*All dimensions are nominal

| Device        | Package Type | Package Drawing | Pins | SPQ  | Length (mm) | Width (mm) | Height (mm) |
|---------------|--------------|-----------------|------|------|-------------|------------|-------------|
| AM26LS32ACDR  | SOIC         | D               | 16   | 2500 | 367.0       | 367.0      | 38.0        |
| AM26LS32ACDR  | SOIC         | D               | 16   | 2500 | 333.2       | 345.9      | 28.6        |
| AM26LS32ACNSR | SO           | NS              | 16   | 2000 | 367.0       | 367.0      | 38.0        |
| AM26LS32ACPWR | TSSOP        | PW              | 16   | 2000 | 367.0       | 367.0      | 35.0        |
| AM26LS32AIDR  | SOIC         | D               | 16   | 2500 | 333.2       | 345.9      | 28.6        |
| AM26LS33ACDR  | SOIC         | D               | 16   | 2500 | 333.2       | 345.9      | 28.6        |



J (R-GDIP-T\*\*)

14 LEADS SHOWN

CERAMIC DUAL IN-LINE PACKAGE



| DIM \ PINS ** | 14                     | 16                     | 18                     | 20                     |
|---------------|------------------------|------------------------|------------------------|------------------------|
| A             | 0.300<br>(7,62)<br>BSC | 0.300<br>(7,62)<br>BSC | 0.300<br>(7,62)<br>BSC | 0.300<br>(7,62)<br>BSC |
| B MAX         | 0.785<br>(19,94)       | .840<br>(21,34)        | 0.960<br>(24,38)       | 1.060<br>(26,92)       |
| B MIN         | —                      | —                      | —                      | —                      |
| C MAX         | 0.300<br>(7,62)        | 0.300<br>(7,62)        | 0.310<br>(7,87)        | 0.300<br>(7,62)        |
| C MIN         | 0.245<br>(6,22)        | 0.245<br>(6,22)        | 0.220<br>(5,59)        | 0.245<br>(6,22)        |



4040083/F 03/03

- NOTES:
- All linear dimensions are in inches (millimeters).
  - This drawing is subject to change without notice.
  - This package is hermetically sealed with a ceramic lid using glass frit.
  - Index point is provided on cap for terminal identification only on press ceramic glass frit seal only.
  - Falls within MIL STD 1835 GDIP1-T14, GDIP1-T16, GDIP1-T18 and GDIP1-T20.

W (R-GDFP-F16)

CERAMIC DUAL FLATPACK



4040180-3/D 07/03

- NOTES:
- A. All linear dimensions are in inches (millimeters).
  - B. This drawing is subject to change without notice.
  - C. This package can be hermetically sealed with a ceramic lid using glass frit.
  - D. Index point is provided on cap for terminal identification only.
  - E. Falls within MIL STD 1835 GDFP1-F16 and JEDEC MO-092AC

FK (S-CQCC-N\*\*)

LEADLESS CERAMIC CHIP CARRIER

28 TERMINAL SHOWN



| NO. OF TERMINALS ** | A                |                  | B                |                  |
|---------------------|------------------|------------------|------------------|------------------|
|                     | MIN              | MAX              | MIN              | MAX              |
| 20                  | 0.342<br>(8,69)  | 0.358<br>(9,09)  | 0.307<br>(7,80)  | 0.358<br>(9,09)  |
| 28                  | 0.442<br>(11,23) | 0.458<br>(11,63) | 0.406<br>(10,31) | 0.458<br>(11,63) |
| 44                  | 0.640<br>(16,26) | 0.660<br>(16,76) | 0.495<br>(12,58) | 0.560<br>(14,22) |
| 52                  | 0.740<br>(18,78) | 0.761<br>(19,32) | 0.495<br>(12,58) | 0.560<br>(14,22) |
| 68                  | 0.938<br>(23,83) | 0.962<br>(24,43) | 0.850<br>(21,6)  | 0.858<br>(21,8)  |
| 84                  | 1.141<br>(28,99) | 1.165<br>(29,59) | 1.047<br>(26,6)  | 1.063<br>(27,0)  |



4040140/D 01/11

- NOTES:
- All linear dimensions are in inches (millimeters).
  - This drawing is subject to change without notice.
  - This package can be hermetically sealed with a metal lid.
  - Falls within JEDEC MS-004

N (R-PDIP-T\*\*)

PLASTIC DUAL-IN-LINE PACKAGE

16 PINS SHOWN



- NOTES:
- A. All linear dimensions are in inches (millimeters).
  - B. This drawing is subject to change without notice.
  - Falls within JEDEC MS-001, except 18 and 20 pin minimum body length (Dim A).
  - The 20 pin end lead shoulder width is a vendor option, either half or full width.

D (R-PDSO-G16)

PLASTIC SMALL OUTLINE



4040047-6/M 06/11

- NOTES:
- A. All linear dimensions are in inches (millimeters).
  - B. This drawing is subject to change without notice.
  -  C. Body length does not include mold flash, protrusions, or gate burrs. Mold flash, protrusions, or gate burrs shall not exceed 0.006 (0,15) each side.
  -  D. Body width does not include interlead flash. Interlead flash shall not exceed 0.017 (0,43) each side.
  - E. Reference JEDEC MS-012 variation AC.

D (R-PDSO-G16)

PLASTIC SMALL OUTLINE



- NOTES:
- All linear dimensions are in millimeters.
  - This drawing is subject to change without notice.
  - Publication IPC-7351 is recommended for alternate designs.
  - Laser cutting apertures with trapezoidal walls and also rounding corners will offer better paste release. Customers should contact their board assembly site for stencil design recommendations. Refer to IPC-7525 for other stencil recommendations.
  - Customers should contact their board fabrication site for solder mask tolerances between and around signal pads.

PW (R-PDSO-G16)

PLASTIC SMALL OUTLINE



- NOTES:
- A. All linear dimensions are in millimeters. Dimensioning and tolerancing per ASME Y14.5M-1994.
  - B. This drawing is subject to change without notice.
  - C. Body length does not include mold flash, protrusions, or gate burrs. Mold flash, protrusions, or gate burrs shall not exceed 0,15 each side.
  - D. Body width does not include interlead flash. Interlead flash shall not exceed 0,25 each side.
  - E. Falls within JEDEC MO-153

PW (R-PDSO-G16)

PLASTIC SMALL OUTLINE



- NOTES:
- All linear dimensions are in millimeters.
  - This drawing is subject to change without notice.
  - Publication IPC-7351 is recommended for alternate designs.
  - Laser cutting apertures with trapezoidal walls and also rounding corners will offer better paste release. Customers should contact their board assembly site for stencil design recommendations. Refer to IPC-7525 for other stencil recommendations.
  - Customers should contact their board fabrication site for solder mask tolerances between and around signal pads.



# MECHANICAL DATA

NS (R-PDSO-G\*\*)

PLASTIC SMALL-OUTLINE PACKAGE

14-PINS SHOWN



- NOTES:
- A. All linear dimensions are in millimeters.
  - B. This drawing is subject to change without notice.
  - C. Body dimensions do not include mold flash or protrusion, not to exceed 0,15.

## IMPORTANT NOTICE

Texas Instruments Incorporated and its subsidiaries (TI) reserve the right to make corrections, enhancements, improvements and other changes to its semiconductor products and services per JESD46C and to discontinue any product or service per JESD48B. Buyers should obtain the latest relevant information before placing orders and should verify that such information is current and complete. All semiconductor products (also referred to herein as "components") are sold subject to TI's terms and conditions of sale supplied at the time of order acknowledgment.

TI warrants performance of its components to the specifications applicable at the time of sale, in accordance with the warranty in TI's terms and conditions of sale of semiconductor products. Testing and other quality control techniques are used to the extent TI deems necessary to support this warranty. Except where mandated by applicable law, testing of all parameters of each component is not necessarily performed.

TI assumes no liability for applications assistance or the design of Buyers' products. Buyers are responsible for their products and applications using TI components. To minimize the risks associated with Buyers' products and applications, Buyers should provide adequate design and operating safeguards.

TI does not warrant or represent that any license, either express or implied, is granted under any patent right, copyright, mask work right, or other intellectual property right relating to any combination, machine, or process in which TI components or services are used. Information published by TI regarding third-party products or services does not constitute a license to use such products or services or a warranty or endorsement thereof. Use of such information may require a license from a third party under the patents or other intellectual property of the third party, or a license from TI under the patents or other intellectual property of TI.

Reproduction of significant portions of TI information in TI data books or data sheets is permissible only if reproduction is without alteration and is accompanied by all associated warranties, conditions, limitations, and notices. TI is not responsible or liable for such altered documentation. Information of third parties may be subject to additional restrictions.

Resale of TI components or services with statements different from or beyond the parameters stated by TI for that component or service voids all express and any implied warranties for the associated TI component or service and is an unfair and deceptive business practice. TI is not responsible or liable for any such statements.

Buyer acknowledges and agrees that it is solely responsible for compliance with all legal, regulatory and safety-related requirements concerning its products, and any use of TI components in its applications, notwithstanding any applications-related information or support that may be provided by TI. Buyer represents and agrees that it has all the necessary expertise to create and implement safeguards which anticipate dangerous consequences of failures, monitor failures and their consequences, lessen the likelihood of failures that might cause harm and take appropriate remedial actions. Buyer will fully indemnify TI and its representatives against any damages arising out of the use of any TI components in safety-critical applications.

In some cases, TI components may be promoted specifically to facilitate safety-related applications. With such components, TI's goal is to help enable customers to design and create their own end-product solutions that meet applicable functional safety standards and requirements. Nonetheless, such components are subject to these terms.

No TI components are authorized for use in FDA Class III (or similar life-critical medical equipment) unless authorized officers of the parties have executed a special agreement specifically governing such use.

Only those TI components which TI has specifically designated as military grade or "enhanced plastic" are designed and intended for use in military/aerospace applications or environments. Buyer acknowledges and agrees that any military or aerospace use of TI components which have **not** been so designated is solely at the Buyer's risk, and that Buyer is solely responsible for compliance with all legal and regulatory requirements in connection with such use.

TI has specifically designated certain components which meet ISO/TS16949 requirements, mainly for automotive use. Components which have not been so designated are neither designed nor intended for automotive use; and TI will not be responsible for any failure of such components to meet such requirements.

### Products

|                        |  |
|------------------------|--|
| Audio                  | <a href="http://www.ti.com/audio">www.ti.com/audio</a>                               |
| Amplifiers             | <a href="http://amplifier.ti.com">amplifier.ti.com</a>                               |
| Data Converters        | <a href="http://dataconverter.ti.com">dataconverter.ti.com</a>                       |
| DLP® Products          | <a href="http://www.dlp.com">www.dlp.com</a>   |
| DSP                    | <a href="http://dsp.ti.com">dsp.ti.com</a>   |
| Clocks and Timers      | <a href="http://www.ti.com/clocks">www.ti.com/clocks</a>                             |
| Interface              | <a href="http://interface.ti.com">interface.ti.com</a>                               |
| Logic                  | <a href="http://logic.ti.com">logic.ti.com</a>                                       |
| Power Mgmt             | <a href="http://power.ti.com">power.ti.com</a>                                       |
| Microcontrollers       | <a href="http://microcontroller.ti.com">microcontroller.ti.com</a>                   |
| RFID                   | <a href="http://www.ti-rfid.com">www.ti-rfid.com</a>                                 |
| OMAP Mobile Processors | <a href="http://www.ti.com/omap">www.ti.com/omap</a>                                 |
| Wireless Connectivity  | <a href="http://www.ti.com/wirelessconnectivity">www.ti.com/wirelessconnectivity</a> |

### Applications

|                               |  |
|-------------------------------|--|
| Automotive and Transportation | <a href="http://www.ti.com/automotive">www.ti.com/automotive</a>                         |
| Communications and Telecom    | <a href="http://www.ti.com/communications">www.ti.com/communications</a>                 |
| Computers and Peripherals     | <a href="http://www.ti.com/computers">www.ti.com/computers</a>                           |
| Consumer Electronics          | <a href="http://www.ti.com/consumer-apps">www.ti.com/consumer-apps</a>                   |
| Energy and Lighting           | <a href="http://www.ti.com/energy">www.ti.com/energy</a>                                 |
| Industrial                    | <a href="http://www.ti.com/industrial">www.ti.com/industrial</a>                         |
| Medical                       | <a href="http://www.ti.com/medical">www.ti.com/medical</a>                               |
| Security                      | <a href="http://www.ti.com/security">www.ti.com/security</a>                             |
| Space, Avionics and Defense   | <a href="http://www.ti.com/space-avionics-defense">www.ti.com/space-avionics-defense</a> |
| Video and Imaging             | <a href="http://www.ti.com/video">www.ti.com/video</a>                                   |

**TI E2E Community** [e2e.ti.com](http://e2e.ti.com)