



Solder

Crimp

- General purpose
- Closed-entry socket contacts
- Solder termination

KPT connectors are a series of general - purpose, environment - resistant, miniature circular connectors, qualified for use in industrial applications calling for quick - disconnect connectors with fixed contacts for solder termination. These miniature circular connectors are grouped into two series ranging from general purpose solder pot connectors . . . to high performance, crimp connectors . . . to connectors with high contact density. This broad range provides the most complete family of 26482 connectors available today. The versatility of these connectors is proven by the fulfillment of requirements ranging from general purpose to space environmental.

In addition to the two basic series, connectors for special applications are also available. They include RFI filtering versions (with loss pass internal filter pin contacts), hermetic connectors for high pressure watertight requirements, and twist - on pull - off couplers for MIL-C-26482 plugs.

This series is intermateable and intermountable with all MIL-C-26482 connectors, whether solder or crimp type and is available with many materials, finishers and configurations.

How to Order - KPT - Solder Contact Connectors

SERIES PREFIX

- KPT - ITT Cannon prefix
- MS - MIL-C-26482 prefix

SHELL STYLE

- Cannon Designation
- 00 - wall mounting receptacle
- 01 - cable connecting plug
- 02 - box mounting receptacle (Class E only)
- * 03 - wall mounting receptacle without grommet, ferrule and endbell
- * 04 - cable connecting plug without grommet, ferrule and endbell
- * 05 - straight plug without grommet, ferrule, and endbell
- 06 - straight plug
- 07 - jam nut receptacle (available in hermetic version also)
- 08 - 90° angle plug
- B - thru-bulkhead receptacle (Class E only)

* Consult factory for details

SHELL STYLE (cont'd)

- MS Designation
- 3110 - wall mounting receptacle
- 3111 - cable connecting plug
- 3112 - box mounting receptacle (Class E only)
- 3114 - jam nut receptacle
- 3116 - straight plug
- 3119 - thru-bulkhead receptacle (Class E only)

SERIES PREFIX

SHELL STYLE

CLASS

SHELL SIZE

CONTACT ARRANGEMENT

CONTACT STYLE

ALTERNATE INSERT POSITION

MODIFICATION CODE

CLASS

- A - general duty (not MS approved)
- B - general duty with strain relief without grommet & ferrules (may be used for potting when strain relief is desired) (not MS approved)
- E - grommet seal except on 02 and 3112 (MS specification)
- F - grommet seal with strain relief (MS specification)
- J - water tight gland seal with strain relief for jacketed cable (MS specification)
- P - potted (MS specification)

SHELL SIZE

- 8, 10, 12, 14, 16, 18, 20, 22, and 24

MS 3110 E 22-36 P Y
KPT 00 E 22-36 P Y **

CONTACT ARRANGEMENT

See contact arrangement page 149.

CONTACT STYLE

P - pin; S - socket

ALTERNATE INSERT POSITION

W, X, Y and Z. (Omit for normal.)

MODIFICATION CODE

- Omit first (0) of shell style indication when using modifications code.
- 07 - clear chromate over cadmium
- 16 - twist-pull lanyard release coupler (applied cable to plug only).
- 23 - grounding springs fingers (applicable to plug only)

How to Order - KPTB Thru-Bulkhead Receptacle Connectors

- General Purpose
- Double ended pin and socket contacts
- Contains KPT socket insert
- Nonremovable contacts

KPT connectors are a series of general - purpose, miniature circular connectors, qualified for use in military applications. They are also widely used in industrial applications. The KPTB in a thru-bulkhead version with double faced pin and socket insert construction allowing mating from both ends. They contain KPT socket inserts with feed-thru (pin/socket) non-removable contacts.

The thru-bulkhead receptacle is provided for applications requiring the disconnection of a power source from either side of a panel. A typical connector to be used if air leakage requirements are critical.

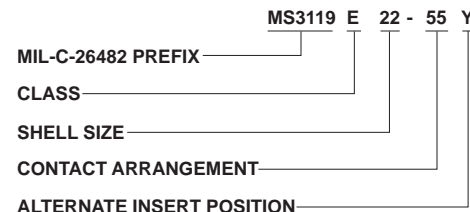
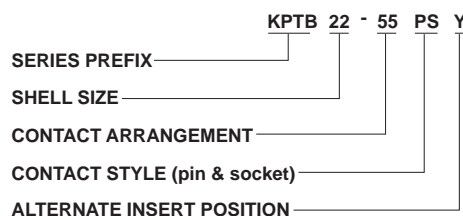

How to Order - KPSE Crimp Contact Connectors

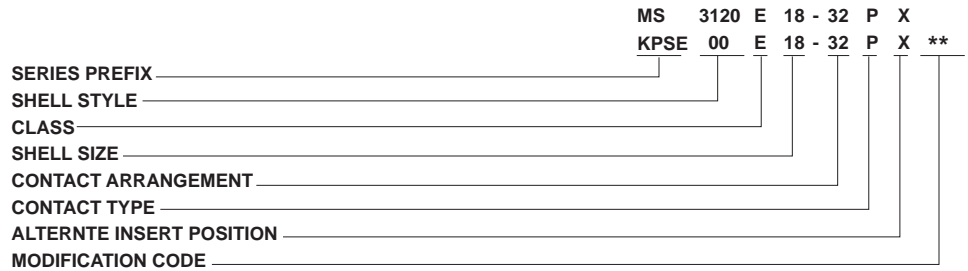

SERIES PREFIX

- KPSE - ITT Cannon prefix
- MS - MIL-C-26482 prefix

SHELL STYLE

- ITT Cannon Number:
- 00 - wall mounting receptacle
 - 01 - cable connecting plug
 - 02 - box mounting receptacle (without wire seals)
 - * 03 - wall mounting receptacle without ferrule and endbell
 - * 04 - cable connector plug without ferrule and endbell
 - * 05 - straight plug without ferrule and endbell
 - 06 - straight plug
 - 07 - jam nut receptacle
 - 08 - 90° angle plug

* Consult factory for details

MS Designation

- 3120 - wall mounting receptacle
- 3121 - cable connecting plug
- 3122 - box mounting receptacle
- 3124 - jam nut receptacle
- 3126 - straight plug

CLASS

- A - general duty (not MS approved)
- B - general duty with strain relief without grommet & ferrules (not MS approved)
- E - grommet seal (MS specification)
- F - grommet seal with strain relief (MS specification)
- J - gland seal with strain relief for jacketed cable (not MS approved)
- P - potted (MS specification)

SHELL SIZE

- 10, 12, 14, 16, 18, 20, 22, and 24

CONTACT ARRANGEMENT

See contact arrangements page 149.

CONTACT STYLE

- P - pin
- S - socket

ALTERNATE INSERT POSITION

W, X, Y and Z. (Omit for normal.)

MODIFICATION CODE

- Omit first (0) of shell style indication when using modifications code.
- F0 - less contacts, not marked on connectors
- 07 - clear chromate over cadmium
- 16 - twist-pull lanyard release coupler (applied cable to plug only).
- 23 - grounding springs fingers (applicable to plug only)

KPSE High Performance Crimp Contact Connectors

- Environment -resistant
- Voidless integrally molded insulator
- Front-release, crimp snap-in contacts
- Closed entry socket contacts
- 4 moisture seals for complete sealing
- Contact clip protected in hard dielectric
- Positive insert-to-shell mechanical retention

KPSE environment-resistant, miniature circular, quick disconnect connectors, qualified to MIL-C-26482, are designed for the exacting requirements of today's electronic industry. The KPSE features an insulator which is mechanically retained in the shell by a positive, hard plastic-to-metal lock retention augmented by a reliable adhesive bond. Complete moisture sealing is achieved by four seal; shell, peripheral, interfacial and wire seals.

Crimp snap-in contacts are retained in clips that are completely encased in a tough hard dielectric wafer, thus protecting the clips tines from damage. Closed-entry socket contacts facilitate positive mating.

The KPSE series is intermateable, intermountable and interchangeable with all MIL-C-26482 connectors, whether crimp or solder type, and is available with many materials, finishes and configurations.

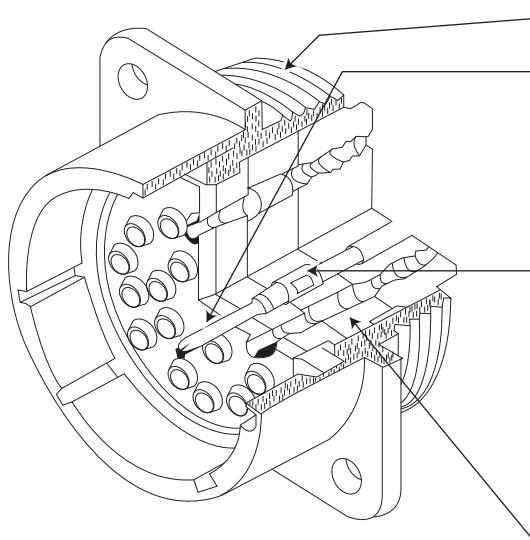

STANDARD MIL-C-26482 HARDWARE mates with any connector designed to MIL-C-26482.

CRIMP, SNAP-IN CONTACTS are designed to MIL-C-39029 and can be crimped with the standard M22520/1 crimp tool.

CLOSED-ENTRY SOCKET CONTACTS eliminate damage from abuse by test probes and help to correct any misaligned pins during engagement. **CONTACT INSERTION** is accomplished from the rear of the connector. When the contact is fully inserted, the clip tines snap securely behind the contact shoulder.

CONTACT EXTRACTION is accomplished with a front-inserted extraction tool. Pressing the tool plunger pushes the contact out thru the rear of the connector.

CONTACT RETAINING CLIP is completely encased in a tough plastic wafer to protect the clip from damage.

COMPLETE MOISTURE SEALING is achieved by combining four seals: shell, peripheral, interfacial and wire seals.

SHELL SEAL is effected when the plug shell pushes against the sealing ring in the receptacle when the connectors are mated.

PERIPHERAL SEAL around the edge of the pin insulator is designed so that mating the connector puts tension on the seal and greatly reduces compression set.

INTERFACIAL SEAL is achieved by the insulator faces meeting when the plug and receptacle are mated.

WIRE SEAL is accomplished by a multiple ripple design, exceeding the wire sealing requirements of MIL-C-26482.

POSITIVE INSERT-TO-SHELL MECHANICAL RETENTION with hard plastic wafer firmly locked into a groove in the shell, in addition to a strong adhesive bond between the insert and shell.

Performance and Material Specifications

STANDARD MATERIALS AND FINISHES

Shell	aluminum alloy, conductive olive drab chromate over cadmium finish per QQ-P-416
Insulator	polychloroprene
Grommet and Seal	polychloroprene
Contacts	Copper alloy, gold plate per MIL-G-45204 type II
Temperature Range	- 55°C to +125°C

MECHANICAL

Shell Sizes	00 - wall mounting receptacle 01 - cable connecting plug 02 - box mounting receptacle 06 - straight plug 07 - jam nut receptacle 08 - 90° angle plug B - thru-bulkhead receptacle (KPT only)
Shell Sizes	KPT 8 thru 24 KPSE 10 thru 24
Polarization/Coupling:	five keyway/three point bayonet
Service Classes	A - general duty B - general duty with strain relief E - grommet seal F - grommet seal with strain relief J - gland nut with strain relief for jacketed cable P - potted

ELECTRICAL

Contact Termination	solder (KPT)	crimp snap-in (KPSE)		
Number of contacts	KPT 2 thru 61	KPSE 3 thru 61		
Wire size, AWG	KPT 12 thru 24	KPSE 16 thru 24		
Wire Range Accommodations	Insulation O.D. Limits			
Contact Size	AWG Wire Size	Min. KPT	Min. KPSE	Max. KPT/ KPSE
20	24, 22 and 20	.060 (1.52)	.047 (1.19)	.083 (2.11)
16	20, 18 and 16	.066 (1.68)	.066 (1.68)	.109 (2.77)
12	14 and 12	.097 (2.46)		.142 (3.61)
Contact Rating	Contact Size	Rated Amps	Test Current	Millivolt Drop
	20	7.5	7.5	less than 55
	16	22.0	13.0	less than 50
Service Rating	Test Volt	Service	AC(rms)	DC
	Sea level	1	1500	2100
		2	2300	3200
	70,000 ft.	1	375	535
		2	550	770
Maximum Operating Voltage	Sea level	1	600	850
		2	1000	1275

Wall Mounting Receptacles

MS3110 (MS service class E, F, J, P)
MS3120 (MS service class E, F, P)

KPT00
KPSE00

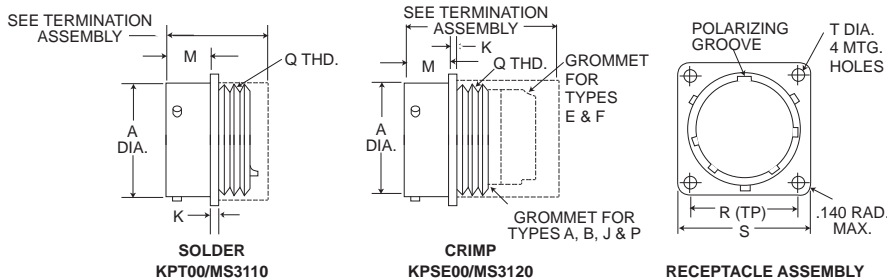

Shell Size	A ± .003 (±.08)	K ± .016 (±.41)	M + .031 (+.79) - .000 (-.00)	R* (TP)	S Max.	T ± .005 (±.13)	Q Thread Class 2A
†8	.471 (11.96)	.062 (1.57)	.431 (10.95)	.594 (15.09)	.828 (21.03)	.120 (3.05)	7/16-28UNEF
10	.588 (14.96)	.062 (1.57)	.431 (10.95)	.719 (18.26)	.954 (24.23)	.120 (3.05)	9/16-24UNEF
12	.748 (19.00)	.062 (1.57)	.431 (10.95)	.812 (20.62)	1.047 (26.59)	.120 (3.05)	11/16-24UNEF
14	.873 (22.17)	.062 (1.57)	.431 (10.95)	.906 (23.01)	1.141 (28.98)	.120 (3.05)	13/16-20UNEF
16	.998 (25.35)	.062 (1.57)	.431 (10.95)	.969 (24.61)	1.234 (31.34)	.120 (3.05)	15/16-20UNEF
18	1.123 (28.52)	.062 (1.57)	.431 (10.95)	1.062 (26.97)	1.328 (33.73)	.120 (3.05)	1-1/16-18UNEF
20	1.248 (31.70)	.094 (2.39)	.556 (14.12)	1.156 (29.36)	1.453 (36.91)	.120 (3.05)	1-3/16-18UNEF
22	1.373 (34.87)	.094 (2.39)	.556 (14.12)	1.250 (31.75)	1.578 (40.08)	.120 (3.05)	1-5/16-18UNEF
24	1.498 (38.05)	.094 (2.39)	.589 (14.96)	1.375 (34.92)	1.703 (43.26)	.147 (3.73)	1-7/16-18UNEF

†Not available in KPSE * (TP) located within .010 T.P. with respect to diameter A and master keyway.

Receptacles with Termination Assemblies

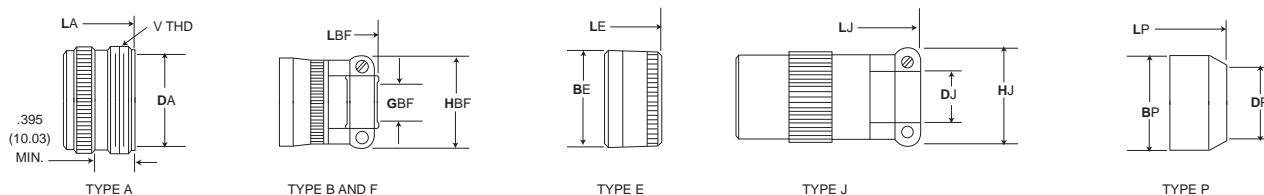

Shell Size	TYPE A			TYPE B and F			TYPE E	
	DA Min.	LA Max.	V Thread Class 2A	GBF Min.	HBF Max.	LBF Max.	BE Max.	LE Max.
†8	.335 (8.15)	1.44 (36.68)	1/2-28UNEF	.115 (2.92)	.828 (21.03)	1.922 (48.82)	.608 (15.44)	1.328 (33.73)
10	.466 (11.84)	1.44 (36.68)	5/8-24UNEF	.178 (4.52)	.891 (22.63)	1.922 (48.82)	.734 (18.64)	1.328 (33.73)
12	.591 (15.01)	1.444 (36.68)	3/4-20UNEF	.302 (7.67)	1.016 (25.81)	1.922 (48.82)	.858 (21.79)	1.328 (33.73)
14	.705 (19.05)	1.444 (36.68)	7/8-20UNEF	.365 (9.27)	1.141 (28.98)	1.922 (48.82)	.984 (24.99)	1.328 (33.73)
16	.830 (21.08)	1.444 (36.68)	1-20UNEF	.490 (12.45)	1.203 (30.56)	2.047 (51.99)	1.110 (28.19)	1.328 (33.73)
18	.948 (24.08)	1.444 (36.68)	1-3/16-18UNEF	.615 (15.62)	1.469 (37.31)	2.078 (52.78)	1.234 (31.34)	1.328 (33.73)
20	1.043 (26.49)	1.728 (43.89)	1-3/16-18UNEF	.615 (15.62)	1.469 (37.31)	2.344 (59.54)	1.360 (34.54)	1.531 (38.89)
22	1.198 (30.43)	1.728 (43.89)	1-7/16-18UNEF	.740 (18.80)	1.656 (42.06)	1.344 (59.54)	1.484 (37.69)	1.531 (38.89)
24	1.293 (32.84)	1.738 (44.15)	1-7/16-18UNEF	.790 (20.07)	1.750 (44.45)	2.406 (61.11)	1.610 (40.89)	1.594 (40.49)

Shell Size	TYPE J			TYPE P		
	DJ Max./Min.	HJ Max.	LJ Max.	BP Max.	DP Min.	LP Max.
†8	.230/.168 (5.84/4.27)	.828 (21.03)	2.271 (57.68)	.608 (15.44)	.317 (8.05)	1.453 (36.91)
10	.312/.205 (7.92/5.21)	.891 (22.63)	2.271 (57.68)	.734 (18.64)	.434 (11.02)	1.453 (36.91)
12	.442/.338 (11.23/8.59)	1.016 (25.81)	2.411 (61.24)	.858 (21.79)	.548 (13.92)	1.453 (36.91)
14	.539/.416 (13.56/10.57)	1.141 (28.98)	2.599 (66.01)	.984 (24.99)	.673 (17.09)	1.453 (36.91)
16	.616/.550 (15.65/13.97)	1.203 (30.56)	2.943 (74.75)	1.110 (28.19)	.798 (20.27)	1.453 (36.91)
18	.672/.600 (17.07/15.24)	1.469 (37.31)	3.172 (80.57)	1.234 (31.34)	.899 (22.83)	1.453 (36.91)
20	.747/.634 (18.97/16.13)	1.469 (37.31)	3.610 (91.69)	1.360 (34.54)	1.024 (26.01)	1.672 (42.47)
22	.846/.670 (21.49/17.02)	1.656 (42.06)	3.766 (95.66)	1.484 (37.69)	1.149 (29.18)	1.672 (42.47)
24	.894/.740 (22.71/18.80)	1.750 (44.45)	3.985 (101.22)	1.610 (40.89)	1.274 (32.36)	1.734 (44.04)

†Not available in KPSE

Performance Specifications - Page 142
Contacts, Sealing Plugs, Assembly Tools - Page 154
Contact Arrangements - Page 149

Cable Connecting Plugs

MS3111
(MS service class E, F, J, P)
MS3121
(MS service class E, F, P)

KPT01
KPSE01

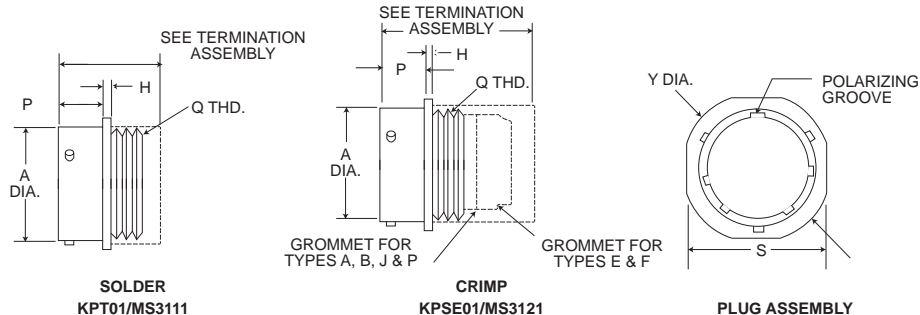

Shell Size	A ± .003 (±.08)	H ± .016 (±.41)	P + .031 (+.79) - .000 (-.00)	S Max.	Y Max.	Q Thread Class 2A
†8	.471 (11.96)	.094 (2.39)	.400 (10.16)	.828 (21.03)	.958 (24.33)	7/16-28UNEF
10	.588 (14.94)	.094 (2.39)	.400 (10.16)	.954 (24.23)	1.082 (27.48)	9/16-24UNEF
12	.748 (19.00)	.094 (2.39)	.400 (10.16)	1.047 (26.59)	1.176 (29.87)	11/16-24UNEF
14	.873 (22.17)	.094 (2.39)	.400 (10.16)	1.141 (28.98)	1.270 (32.26)	13/16-20UNEF
16	.998 (25.35)	.094 (2.39)	.400 (10.16)	1.234 (31.34)	1.364 (34.65)	15/16-20UNEF
18	1.123 (28.52)	.094 (2.39)	.400 (10.16)	1.328 (33.73)	1.458 (37.03)	1-1/16-18UNEF
20	1.248 (31.70)	.115 (2.92)	.535 (13.59)	1.453 (36.91)	1.582 (40.18)	1-3/16-18UNEF
22	1.373 (34.87)	.115 (2.92)	.535 (13.59)	1.578 (40.08)	1.708 (43.38)	1-5/16-18UNEF
24	1.498 (38.05)	.115 (2.92)	.558 (14.43)	1.703 (43.26)	1.832 (46.53)	1-7/16-18UNEF

†Not available in KPSE *(TP) located within .010T.P. with respect to diameters A and master keyway.

Cable Connecting Plugs With Termination Assemblies

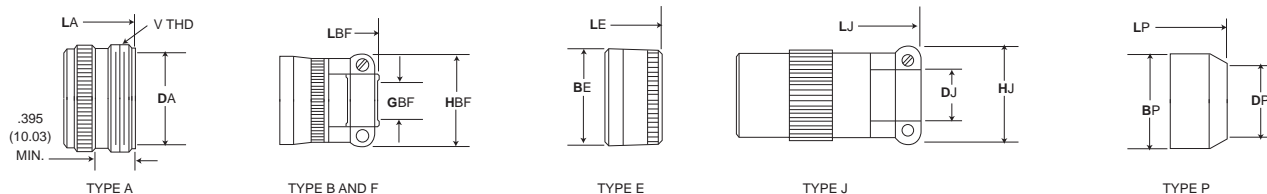

With Termination Assemblies

Shell Size	TYPE A			TYPE B and F			TYPE E	
	DA Min.	LA Max.	V Thread Class 2A	GBF Min.	HBF Max.	LBF Max.	BE Max.	LE Max.
†8	.335 (8.15)	1.44 (36.68)	1/2-28UNEF	.115 (2.92)	.828 (21.03)	1.922 (48.82)	.608 (15.44)	1.328 (33.73)
10	.466 (11.84)	1.44 (36.68)	5/8-24UNEF	.178 (4.52)	.891 (22.63)	1.922 (48.82)	.734 (18.64)	1.328 (33.73)
12	.591 (15.01)	1.44 (36.68)	3/4-20UNEF	.302 (7.67)	1.016 (25.81)	1.922 (48.82)	.858 (21.79)	1.328 (33.73)
14	.705 (19.05)	1.44 (36.68)	7/8-20UNEF	.365 (9.27)	1.141 (28.98)	1.922 (48.82)	.984 (24.99)	1.328 (33.73)
16	.830 (21.08)	1.44 (36.68)	1-20UNEF	.490 (12.45)	1.203 (30.56)	2.047 (51.99)	1.110 (28.19)	1.328 (33.73)
18	.948 (24.08)	1.44 (36.68)	1-3/16-18UNEF	.615 (15.62)	1.469 (37.31)	2.078 (52.78)	1.234 (31.34)	1.328 (33.73)
20	1.043 (26.49)	1.728 (43.89)	1-3/16-18UNEF	.615 (15.62)	1.469 (37.31)	2.344 (59.54)	1.360 (34.54)	1.531 (38.89)
22	1.198 (30.43)	1.728 (43.89)	1-7/16-18UNEF	.740 (18.80)	1.656 (42.06)	1.344 (59.54)	1.484 (37.69)	1.531 (38.89)
24	1.293 (32.84)	1.738 (44.15)	1-7/16-18UNEF	.790 (20.07)	1.750 (44.45)	2.406 (61.11)	1.610 (40.89)	1.594 (40.49)

Shell Size	TYPE J			TYPE P		
	DJ Max./Min.	HJ Max.	LJ Max.	BP Max.	DP Min.	LP Max.
†8	.230/.168 (5.84/4.27)	.828 (21.03)	2.271 (57.68)	.608 (15.44)	.317 (8.05)	1.453 (36.91)
10	.312/.205 (7.92/5.21)	.891 (22.63)	2.271 (57.68)	.734 (18.64)	.434 (11.02)	1.453 (36.91)
12	.442/.338 (11.23/8.59)	1.016 (25.81)	2.411 (61.24)	.858 (21.79)	.548 (13.92)	1.453 (36.91)
14	.539/.416 (13.56/10.57)	1.141 (28.98)	2.599 (66.01)	.984 (24.99)	.673 (17.09)	1.453 (36.91)
16	.616/.550 (15.65/13.97)	1.203 (30.56)	2.943 (74.75)	1.110 (28.19)	.798 (20.27)	1.453 (36.91)
18	.672/.600 (17.07/15.24)	1.469 (37.31)	3.172 (80.57)	1.234 (31.34)	.899 (22.83)	1.453 (36.91)
20	.747/.634 (18.97/16.13)	1.469 (37.31)	3.610 (91.69)	1.360 (34.54)	1.024 (26.01)	1.672 (42.47)
22	.846/.670 (21.49/17.02)	1.656 (42.06)	3.766 (95.66)	1.484 (37.69)	1.149 (29.18)	1.672 (42.47)
24	.894/.740 (22.71/18.80)	1.750 (44.45)	3.985 (101.22)	1.610 (40.89)	1.274 (32.36)	1.734 (44.04)

†Not available in KPSE

Performance Specifications - Page 142
Contacts, Sealing Plugs, Assembly Tools - Page 154

Contact Arrangements - Page 149

Box Mounting Receptacles

MS3112
(MS service class E)
MS3122
(MS service class E)

KPT02

KPSE02

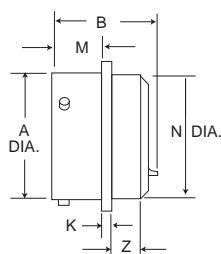

SOLDER
KPT02/MS3112

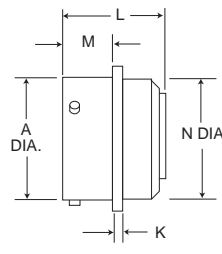

CRIMP
KPSE02/MS3122

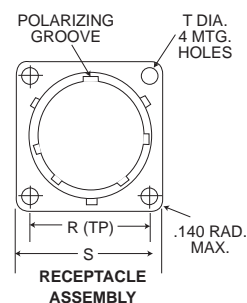

RECEPTACLE
ASSEMBLY

Note: Connector does not accommodate backshell.

Shell Size	A ± .003 (±.08)	B Max	K ± .016 (±.41)	L Max.	M + .031 (+.79) - .000 (-.00)	N Dia. Max.	R* (TP)	S Max.	T ± .005	Z Max.
†8	.471 (11.96)	.978 (12.14)	.062 (1.57)	1.320 (33.07)	.431 (10.95)	.469 (11.91)	.594 (15.09)	.828 (21.03)	.120 (3.05)	.354 (8.99)
10	.588 (14.96)	.978 (12.14)	.062 (1.57)	1.320 (33.07)	.431 (10.95)	.593 (15.06)	.719 (18.26)	.954 (24.23)	.120 (3.05)	.354 (8.99)
12	.748 (19.00)	.978 (12.14)	.062 (1.57)	1.320 (33.07)	.431 (10.95)	.719 (18.26)	.812 (20.62)	1.047 (26.59)	.120 (3.05)	.354 (8.99)
14	.873 (22.17)	.978 (12.14)	.062 (1.57)	1.320 (33.07)	.431 (10.95)	.843 (21.41)	.906 (23.01)	1.141 (28.98)	.120 (3.05)	.354 (8.99)
16	.998 (25.35)	.978 (12.14)	.062 (1.57)	1.320 (33.07)	.431 (10.95)	.969 (24.61)	.969 (24.61)	1.234 (31.34)	.120 (3.05)	.354 (8.99)
18	1.123 (28.52)	.978 (12.14)	.062 (1.57)	1.320 (33.07)	.431 (10.95)	1.093 (27.76)	1.062 (26.97)	1.328 (33.73)	.120 (3.05)	.354 (8.99)
20	1.248 (31.70)	1.196 (30.38)	.094 (2.39)	1.367 (34.72)	.556 (14.12)	1.219 (30.96)	1.156 (29.36)	1.453 (36.91)	.120 (3.05)	.417 (10.59)
22	1.373 (34.87)	1.196 (30.38)	.094 (2.39)	1.367 (34.72)	.556 (14.12)	1.343 (34.11)	1.250 (31.75)	1.578 (40.08)	.120 (3.05)	.417 (10.59)
24	1.498 (38.05)	1.196 (30.98)	.094 (2.39)	1.418 (36.02)	.589 (14.96)	1.469 (37.31)	1.375 (34.92)	1.703 (43.26)	.147 (3.73)	.445 (11.30)

†Not available in KPSE *(TP) located within .010T.P. with respect to diameter A and master keyway.

Thru-Bulkhead Receptacles

MS3119
(MS service class E)

KPTB

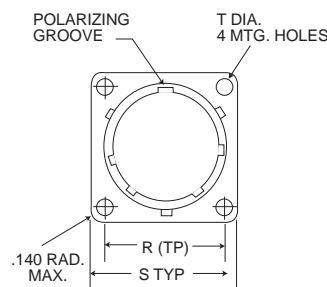
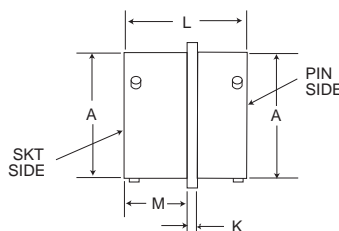

*(T.P) located within .010 T.P. with respect to diameter A and master keyway.

Shell Size	A Dia. ± .003 (±.08)	K ± .016 (±.406)	L Max.	M + .031 (+.79) - .000 (-.00)	R* (TP)	S Max.	T ± .005 (± .127)
†8	.471 (11.96)	.062 (1.57)	1.125 (28.58)	.562 (14.27)	.594 (15.09)	.828 (21.03)	.120 (3.05)
10	.588 (14.94)	.062 (1.57)	1.125 (28.58)	.562 (14.27)	.719 (18.26)	.954 (24.23)	.120 (3.05)
12	.748 (18.00)	.062 (1.57)	1.125 (28.58)	.562 (14.27)	.812 (20.62)	1.047 (26.59)	.120 (3.05)
14	.873 (22.17)	.062 (1.57)	1.125 (28.58)	.562 (14.27)	.906 (23.01)	1.141 (28.98)	.120 (3.05)
16	.998 (25.35)	.062 (1.57)	1.125 (28.58)	.562 (14.27)	.969 (24.61)	1.234 (31.34)	.120 (3.05)
18	1.123 (28.52)	.062 (1.57)	1.125 (28.58)	.562 (14.27)	1.062 (26.97)	1.328 (33.73)	.120 (3.05)
20	1.248 (31.70)	.094 (2.39)	1.406 (35.71)	.688 (17.48)	1.156 (29.36)	1.453 (36.91)	.120 (3.05)
22	1.373 (34.87)	.094 (2.39)	1.406 (35.71)	.688 (17.48)	1.250 (31.76)	1.578 (40.08)	.120 (3.05)
24	1.498 (38.05)	.094 (2.39)	1.406 (35.71)	.688 (17.48)	1.375 (34.92)	1.703 (43.26)	.147 (3.73)

Performance Specifications - Page 142

Contacts, Sealing Plugs, Assembly Tools - Page 154

Contact Arrangements - Page 149

Straight Plugs

MS3116
(MS service class E, F, J, P)
MS3126
(MS service class E, F, P)

KPT06
KPSE06

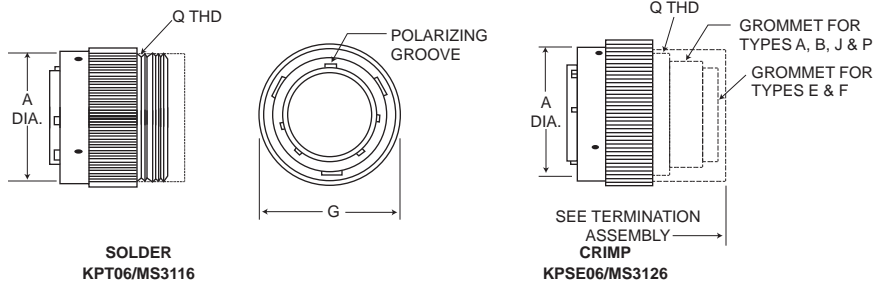

SOLDER
KPT06/MS3116

KPSE06/MS3126

Shell Size	A dia. Max.	G Max.	J $\pm .010 (\pm 0.25)$	Q Thread Class 2A
†8	.765 (19.43)	.782 (19.86)	.353 (8.99)	7/16-28UNEF
10	.840 (21.34)	.926 (23.52)	.353 (8.99)	9/16-24UNEF
12	.999 (25.38)	1.043 (26.49)	.353 (8.99)	11/16-24UNEF
14	1.139 (28.93)	1.183 (30.05)	.353 (8.99)	13/16-20UNEF
16	1.261 (32.03)	1.305 (33.15)	.353 (8.99)	15/16-20UNEF
18	1.337 (33.96)	1.391 (35.33)	.353 (8.99)	1-1/16-18UNEF
20	1.477 (37.52)	1.531 (38.89)	.415 (10.54)	1-3/16-18UNEF
22	1.602 (40.69)	1.656 (42.06)	.415 (10.54)	1-5/16-18UNEF
24	1.723 (43.76)	1.77 (45.14)	.415 (10.54)	1-7/16-18UNEF

†Not available in KPSE

Straight Plugs With Termination Assemblies

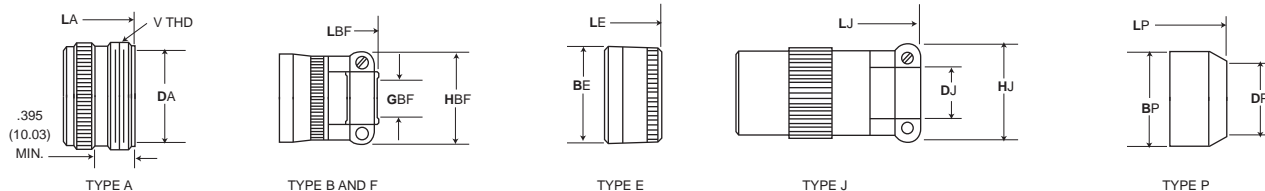

Shell Size	TYPE A			TYPE B and F			TYPE E	
	LA Max.	DA Min.	V Thread Class 2A	LBF Max.	HBF Max.	GBF Min.	BE Max.	LE Max.
†8	1.440 (36.58)	.335 (8.51)	1/2-28UNEF	1.906 (48.41)	.828 (21.03)	.115 (2.02)	.608 (15.44)	1.328 (33.73)
10	1.440 (36.58)	.466 (11.84)	5/8-24UNEF	1.906 (48.41)	.891 (22.63)	.178 (4.52)	.734 (18.64)	1.328 (33.73)
12	1.440 (36.58)	.591 (15.01)	3/4-20UNEF	1.906 (48.41)	1.016 (25.81)	.302 (7.67)	.858 (21.79)	1.328 (33.73)
14	1.440 (36.58)	.705 (19.05)	7/8-20UNEF	1.906 (48.41)	1.141 (28.98)	.365 (9.27)	.984 (24.99)	1.328 (33.73)
16	1.440 (36.58)	.830 (21.08)	1-20UNEF	2.047 (51.99)	1.203 (30.56)	.490 (12.45)	1.110 (28.19)	1.328 (33.73)
18	1.662 (42.21)	.948 (24.08)	1-3/16-18UNEF	2.078 (52.78)	1.469 (37.31)	.615 (15.62)	1.234 (31.34)	1.328 (33.73)
20	1.662 (42.21)	1.043 (26.49)	1-3/16-18UNEF	2.250 (57.15)	1.469 (37.31)	.615 (15.62)	1.360 (34.54)	1.453 (36.91)
22	1.662 (42.21)	1.198 (30.43)	1-7/16-18UNEF	2.250 (57.15)	1.656 (42.06)	.740 (18.80)	1.484 (37.69)	1.453 (36.91)
24	1.672 (42.47)	1.293 (32.84)	1-7/16-18UNEF	2.312 (58.72)	1.750 (44.45)	.790 (20.07)	1.610 (40.89)	1.510 (38.54)

Shell Size	TYPE J			TYPE P		
	LJ Max.	HJ Max.	DJ Max./Min.	LP Max.	DP Min.	BP Max.
†8	2.271 (57.68)	.828 (21.03)	.230/.168 (5.84/4.27)	1.500 (38.10)	.317 (8.05)	.608 (15.44)
10	2.271 (57.68)	.891 (22.63)	.312/.205 (7.92/5.21)	1.500 (38.10)	.434 (11.02)	.734 (18.64)
12	2.411 (61.24)	1.016 (25.81)	.442/.338 (11.23/8.59)	1.500 (38.10)	.548 (13.92)	.858 (21.79)
14	2.599 (66.01)	1.141 (28.98)	.539/.416 (13.56/10.57)	1.500 (38.10)	.673 (17.09)	.984 (24.99)
16	2.943 (74.75)	1.203 (30.56)	.616/.550 (15.65/13.97)	1.500 (38.10)	.798 (20.27)	1.110 (28.19)
18	3.172 (80.57)	1.469 (37.31)	.672/.600 (17.07/15.24)	1.500 (38.10)	.899 (22.83)	1.234 (31.34)
20	3.610 (91.69)	1.469 (37.31)	.747/.634 (18.97/16.13)	1.609 (40.87)	1.024 (26.01)	1.360 (34.54)
22	3.766 (95.66)	1.656 (42.06)	.846/.670 (21.49/17.02)	1.609 (40.87)	1.149 (29.18)	1.484 (37.69)
24	3.985 (101.22)	1.750 (44.45)	.894/.740 (22.71/18.80)	1.687 (42.85)	1.274 (32.36)	1.610 (40.89)

†Not available in KPSE

Performance Specifications - Page 142
Contacts, Sealing Plugs, Assembly Tools - Page 154
Contact Arrangements - Page 149

Jam Nut Receptacles

MS3114
(MS service class E, F, P)
MS3124
(MS service class E, F, P)

KPT07
KPSE07

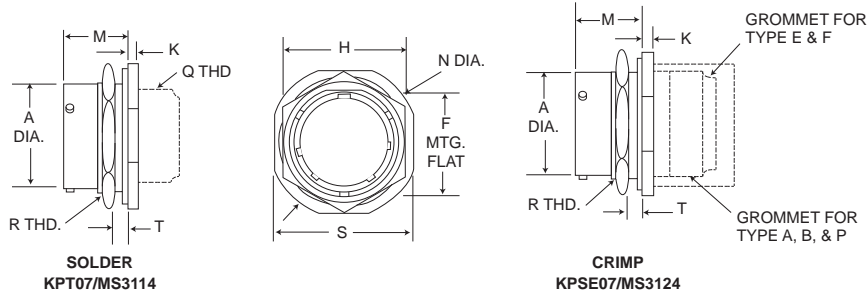

Shell Size	A		H	K	M		N Max.	S Max.	T		R thread Class 2A
	±.003 (±0.08)	±.005 (0.130)			±.017 (±0.43)	±.020 (±.05)			+0.031 (+.08) -0.000 (-.00)	Panel Thickness Min.	
†8	.471 (11.96)	.525 (13.34)	.750 (19.05)	.117 (2.97)	.691 (17.55)	1.078 (27.38)	.954 (24.23)	.062 (1.57)	.125 (3.17)	9/16-24UNEF	
10	.588 (14.93)	.650 (16.51)	.875 (22.22)	.117 (2.97)	.691 (17.55)	1.206 (30.56)	1.078 (27.38)	.062 (1.57)	.125 (3.17)	11/16-24UNEF	
12	.748 (19.00)	.813 (20.65)	1.062 (26.97)	.117 (2.97)	.691 (17.55)	1.319 (35.33)	1.266 (32.16)	.062 (1.57)	.125 (3.17)	7/8-20UNEF	
14	.873 (22.17)	.937 (23.80)	1.188 (30.17)	.117 (2.97)	.691 (17.55)	1.516 (38.51)	1.391 (35.33)	.062 (1.57)	.125 (3.17)	1-20UNEF	
16	.988 (25.35)	1.061 (26.95)	1.312 (33.32)	.117 (2.97)	.691 (17.55)	1.641 (41.68)	1.516 (38.51)	.062 (1.57)	.125 (3.17)	1-1/8-18UNEF	
18	1.123 (28.52)	1.186 (30.12)	1.438 (36.25)	.117 (2.97)	.691 (17.55)	1.766 (44.86)	1.41 (41.68)	.062 (1.57)	.125 (3.17)	1-1/4-18UNEF	
20	1.248 (31.70)	1.311 (33.30)	1.562 (39.67)	.148 (3.76)	.879 (22.33)	1.954 (49.63)	1.828 (46.43)	.062 (1.57)	.250 (6.35)	1-3/8-18UNEF	
22	1.373 (34.87)	1.436 (36.47)	1.688 (42.87)	.148 (3.76)	.879 (22.33)	2.078 (52.78)	1.954 (49.63)	.062 (1.57)	.250 (6.35)	1-1/2-18UNEF	
24	1.498 (38.05)	1.561 (39.65)	1.812 (46.02)	.148 (3.76)	.912 (23.16)	2.203 (55.96)	2.078 (52.78)	.062 (1.57)	.250 (6.35)	1-5/8-18UNEF	

†Not available in KPSE

Jam Nut Receptacles With Termination Assemblies

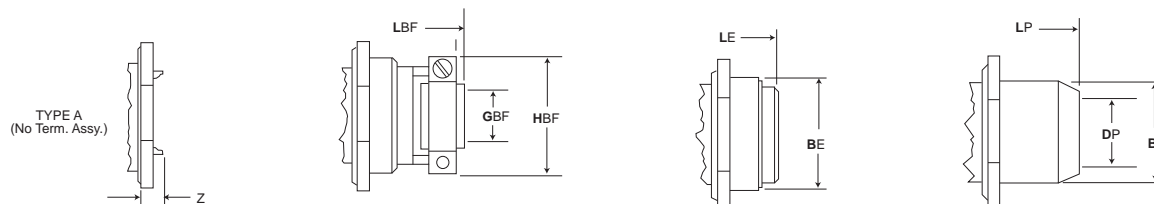

Shell Size	TYPE A	TYPE B AND F			TYPE E		TYPE P		
	Z Max.	HBF Max.	GBF Min.	LBF Max.	BE Max.	LE Max.	BP Max.	DP Min.	LP Max.
†8	.312 (7.92)	.828 (21.03)	.115 (2.02)	1.906 (48.41)	.608 (15.44)	1.344 (34.14)	.608 (15.44)	.317 (8.05)	1.391 (35.33)
10	.312 (7.92)	.891 (22.63)	.178 (4.52)	1.906 (48.41)	.734 (18.64)	1.344 (34.14)	.734 (18.64)	.434 (11.02)	1.391 (35.33)
12	.312 (7.92)	1.016 (25.81)	.302 (7.67)	1.906 (48.41)	.858 (21.79)	1.344 (34.14)	.858 (21.79)	.548 (13.92)	1.391 (35.33)
14	.312 (7.92)	1.141 (28.98)	.365 (9.27)	1.906 (48.41)	.984 (24.99)	1.344 (34.14)	.984 (24.99)	.673 (17.09)	1.391 (35.33)
16	.312 (7.92)	1.203 (30.56)	.490 (12.45)	2.047 (51.99)	1.110 (28.19)	1.344 (34.14)	1.110 (28.19)	.798 (20.27)	1.391 (35.33)
18	.312 (7.92)	1.469 (37.31)	.615 (15.62)	2.078 (52.78)	1.234 (31.34)	1.344 (34.14)	1.234 (31.34)	.899 (22.83)	1.391 (35.33)
20	1.93 (4.90)	1.469 (37.31)	.615 (15.62)	2.328 (59.13)	1.360 (34.54)	1.594 (40.49)	1.360 (34.54)	1.024 (26.01)	1.641 (41.68)
22	1.93 (4.90)	1.656 (42.06)	.740 (18.80)	2.328 (59.13)	1.484 (37.69)	1.594 (40.49)	1.484 (37.69)	1.149 (29.18)	1.641 (41.68)
24	.150 (3.81)	1.750 (44.45)	.790 (20.07)	2.453 (62.31)	1.610 (40.89)	1.641 (41.68)	1.610 (40.89)	1.274 (32.36)	1.703 (43.26)

Performacne Specifications - Page 142

Contacts, Sealing Plugs, Assembly Tools - Page 154

Contact Arrangements - Page 149

Right Angle Plugs

KPT08/KPSE08

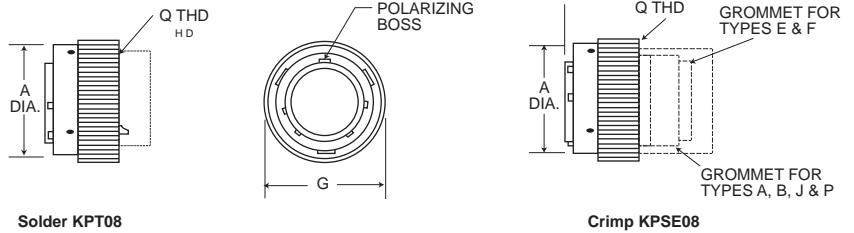

Shell Size	KPT/KPSE		Q Thread Class 2A
	A Dia. Max.	G Max.	
†8	.765 (19.43)	.782 (19.86)	7/16-28UNEF
10	.840 (21.34)	.926 (23.52)	9/16-24UNEF
12	.999 (25.38)	1.043 (26.49)	11/16-24UNEF
14	1.139 (28.93)	1.183 (30.05)	13/16-20UNEF
16	1.261 (32.03)	1.305 (33.15)	15/16-20UNEF
18	1.337 (33.96)	1.391 (35.33)	1-1/16-18UNEF
20	1.477 (37.52)	1.531 (38.89)	1-3/16-18UNEF
22	1.602 (40.69)	1.656 (42.09)	1-5/16-18UNEF
24	1.723 (43.76)	1.777 (45.13)	1-7/16-18UNEF

†Not available in KPSE.
 NOTE: for size 10 and 24 consult factory for availability in type A, B, E and F,
 For size 8 consult factory for availability in Type P.

Right Angle Plugs With Termination Assemblies

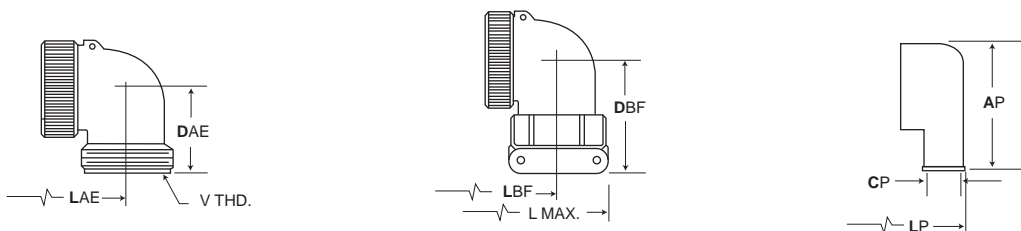

Shell Size	TYPE A AND E			TYPE B AND F				TYPE P			
	LAE Max.	DAE Max.	V Thread Class 2A	DBF Max.	LBF Max.	L Max.	V Thread Class 2A	AP Max.	LP Max.	CP Min.	V Thread Class 2A
†8	1.421 (36.09)	.822 (20.88)	1/2-28UNEF	1.238 (31.44)	1.421 (36.09)	1.842 (46.79)	1/2-28UNEF	-(-)	-(-)	-(-)	1/2-28UNEF
10	1.484 (37.69)	.853 (21.67)	5/8-28UNEF	1.269 (32.24)	1.484 (37.69)	1.937 (49.20)	5/8-28UNEF	1.030 (26.16)	1.380 (35.05)	.252 (6.40)	5/8-28UNEF
12	1.546 (39.27)	.916 (23.27)	3/4-20UNEF	1.395 (35.43)	1.546 (39.27)	1.937 (49.20)	3/4-20UNEF	1.030 (26.16)	1.567 (39.80)	.252 (6.40)	3/4-20UNEF
14	1.577 (40.05)	.978 (24.84)	7/8-20UNEF	1.519 (38.58)	1.577 (40.05)	2.124 (53.95)	7/8-20UNEF	1.030 (26.16)	1.567 (39.80)	.283 (7.19)	7/8-20UNEF
16	1.609 (40.87)	1.041 (26.44)	1-20UNEF	1.582 (40.18)	1.609 (40.87)	2.203 (55.96)	1-20UNEF	1.280 (32.51)	1.567 (39.80)	.355 (9.02)	1-20UNEF
18	1.734 (44.04)	1.103 (28.70)	1-3/16-18UNEF	1.644 (41.76)	1.734 (44.04)	2.380 (60.45)	1-3/16-18UNEF	1.280 (32.51)	1.755 (44.58)	.530 (13.46)	1-3/16-18UNEF
20	1.879 (47.73)	1.166 (29.62)	1-5/16-18UNEF	1.707 (43.36)	1.879 (47.73)	2.629 (66.78)	1-5/16-18UNEF	1.530 (38.86)	1.782 (45.26)	.562 (14.27)	1-5/16-18UNEF
22	2.035 (51.69)	1.245 (31.62)	1-7/16-18UNEF	1.884 (47.85)	2.035 (51.69)	2.629 (66.78)	1-7/16-18UNEF	1.530 (38.86)	1.782 (45.26)	.562 (14.27)	1-7/16-18UNEF
24	2.035 (51.69)	1.322 (33.58)	1-7/16-18UNEF	1.963 (49.86)	2.035 (51.69)	2.895 (73.53)	1-7/16-18UNEF	1.780 (45.21)	2.087 (53.01)	.610 (15.49)	1-7/16-18UNEF

†Not available in KPSE. NOTE: For size 10 and 24 consult factory for availability in type A, B, E and F, For size 8 consult factory for availability in Type P.

Performance Specifications - Page 142
 Contacts, Sealing Plugs, Assembly Tools - Page 154
 Contact Arrangements - Page 149

Contact Arrangements

LEGEND

- ▲ KPT
- ◆ KPSE
- △ Authorized per MIL-C-26482 (NAVY)
- Not MS approved ITTC proprietary

Drawing not to scale; face view of pin insert shown (socket view is opposite)

Shell Size	No. of Contacts	Service Rating
Shell Size 8		
	8-2 2-#20	I
	8-3 3-#20	I
	8-4 4-#20	I
	8-33 3-#20	I
Shell Size 10		
	10-6 6-#20	I
	10-98 6-#20	I
Shell Size 12		
	12-3 3-#16	II
	12-8 8-#20	I
	12-10 10-#20	I
Shell Size 14		
	14-5 5-#16	II
	14-12 8-#20 4-#16	I
	14-15 14-#20 1-#16	I
Shell Size 16		
	16-8 8-#16	II
	16-23 22-#20 1-#16	I
	16-26 26-#20	I
	16-99 21-#20 2-#16	I
Shell Size 18		
	18-11 11-#16	II
	18A28 26-#20 2-#16	I
Shell Size 20		
	18-30 29-#20 1-#16	I
	18-32 32-#20	I
	20-16 16-#16	II
	20-24 24-#20	I
	20-39 37-#20 2-#16	I
	20-41 41-#20	I
Shell Size 22		
	22-21 21-#16	II
	22-32 32-#20	I
	22-34 34-#20	I
	22-36 36-#20	I
	22-41 27-#20 14-#16	II
	22-55 55-#20	I
Shell Size 24		
	24A57 55-#20 2-#12	I
	24-61 61-#20	I

(See page 150 for Alternate Insert Positions.)

Alternate Insert Positions

Face view of pin inserts

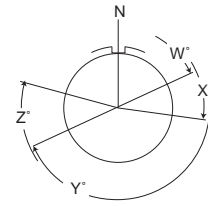

The five positions (W, X, Y, Z and Normal) differ in degree of rotation for various sizes and arrangements.

NO. OF CONTACTS	SHELL SIZE	ARR. NO.	W	Degrees of Rotation			
				X	Y	Z	
2	8	8-2	58	122	-	-	
	8	8-3	60	210	-	-	
3	8	8-33	90	-	-	-	
	12	12-3	-	-	180	-	
4	8	8-4	45	-	-	-	
5	14	14-5	40	92	184	273	
6	10	10-6	90	-	-	-	
	10	10-98	90	180	240	270	
8	12	12-8	90	112	203	292	
	16	16-8	54	152	180	331	
10	12	12-10	60	155	270	295	
11	18	18-11	62	119	241	340	
12	14	14-12	43	90	-	-	
15	14	14-15	17	110	155	234	
16	20	20-16	238	318	333	347	
18	14	14-18	15	90	180	270	
19	14	14-19	30	165	315	-	
21	22	22-21	16	135	175	349	
	16	16-23	158	270	-	-	
23	16	16-99	66	156	223	340	
	20	20-24	70	145	215	290	
26	16	16-26	60	-	275	338	
28	18	18A28	-	-	-	-	
30	18	18-30	180	193	285	350	
32	18	18-32	85	138	222	265	
	22	22-32	72	145	215	288	
34	22	22-34	62	142	218	298	
36	22	22-36	72	144	216	288	
39	20	20-39	63	144	252	333	
41	20	20-41	45	126	225	-	
	22	22-41	39	135	264	-	
55	22	22-55	30	142	226	314	
57	24	24A57	90	180	270	324	
61	24	24-61	90	180	270	324	

Numbers in bold face indicate contact arrangements are not to MIL-C-26482.

Panel Cutouts

Box and Wall Mounting Receptacle

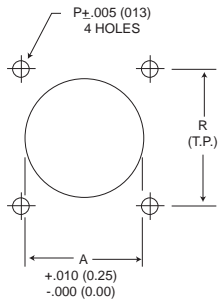

Shell Size	FLANGE (FRONT MOUNTING) KPT/KPSE		MOUNTING HOLE DIA. KPT/KPSE	
	A Dia.	R	P ±.005	Screw
†8	.618 (15.70)	.594 (15.09)	.125 (3.17)	#4
10	.735 (18.67)	.719 (18.26)	.125 (3.17)	#4
12	.859 (21.82)	.812 (20.62)	.125 (3.17)	#4
14	.985 (25.02)	.906 (23.01)	.125 (3.17)	#4
16	1.113 (28.27)	.969 (24.61)	.125 (3.17)	#4
18	1.235 (31.37)	1.062 (26.97)	.125 (3.17)	#4
20	1.361 (34.57)	1.156 (29.36)	.125 (3.17)	#4
22	1.485 (37.72)	1.250 (31.75)	.125 (3.17)	#4
24	1.611 (40.92)	1.375 (34.92)	.155 (3.94)	#6

†Not Available in KPSE connectors.

Jam Nut Receptacle

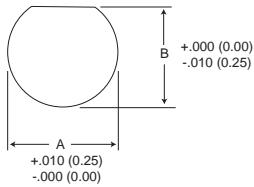

Shell Size	KPT/KPSE	
	A	B
†8	.578 (14.68)	.540 (13.72)
10	.703 (17.86)	.665 (16.89)
12	.890 (22.61)	.828 (21.02)
14	1.015 (25.78)	.952 (24.18)
16	1.140 (28.96)	1.076 (27.33)
18	1.265 (32.13)	1.201 (30.51)
20	1.390 (35.31)	1.326 (33.68)
22	1.515 (38.48)	1.451 (36.86)
24	1.640 (41.66)	1.576 (40.03)

†Not Available in KPSE connectors.

Panel Thickness

Maximum panel thickness dimensions allowable to ensure complete connector operation for the Wall Mounting Receptacle, Box Mounting Receptacle, and Thru-Bulkhead Receptacle.

Wall Mounting and Box Mounting Receptacle

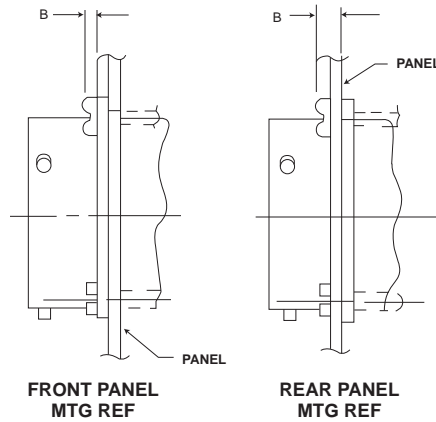

Size	B Max
8	.087 (2.21)
10	
12	
14	
16	
18	.212 (5.38)
20	
22	
24	

Thru-Bulkhead Receptacle

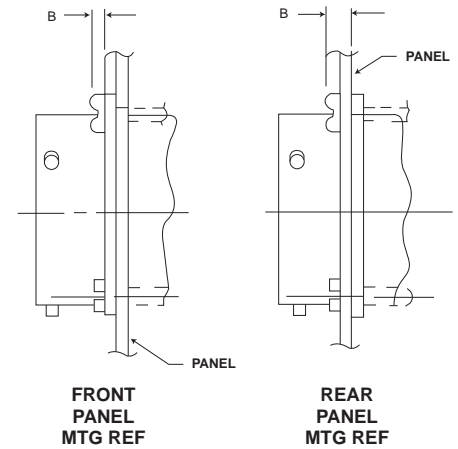

Size	B Max panel and screw head
8	.218 (5.54)
10	
12	
14	
16	
18	.334 (8.74)
20	
22	
24	

Dummy Receptacles

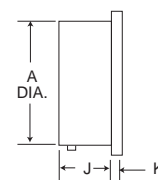
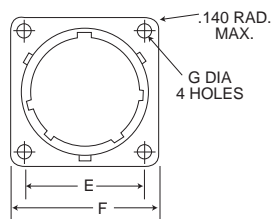
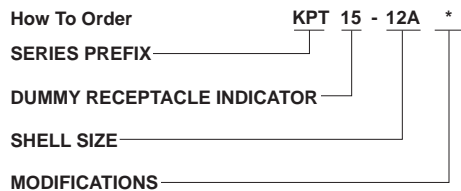

SERIES PREFIX
KPT - ITT Cannon Prefix

NOTE: For MS Version and additional finishes see PV catalog.

SHELL SIZE
8 thru 24

MODIFICATIONS
None - Olive drab chromate over cadmium

Shell Size	A ± .003 (.08)	E Basic	F Max.	G ± .005 (.13)	J +.031 (.79) -.000 (.00)	K ± .016 (.41)
8	.471 (11.96)	.594 (15.09)	.828 (21.03)	.120 (3.05)	.412 (10.46)	.062 (1.57)
10	.588 (14.94)	.719 (18.26)	.954 (24.23)	.120 (3.05)	.412 (10.46)	.062 (1.57)
12	.748 (19.00)	.812 (20.62)	1.047 (26.60)	.120 (3.05)	.412 (10.46)	.062 (1.57)
14	.873 (22.17)	.906 (23.01)	1.141 (28.98)	.120 (3.05)	.412 (10.46)	.062 (1.57)
16	.998 (25.35)	.969 (24.61)	1.234 (31.34)	.120 (3.05)	.412 (10.46)	.062 (1.57)
18	1.123 (28.52)	1.157 (26.97)	1.328 (33.73)	.120 (3.05)	.462 (11.73)	.062 (1.57)
20	1.248 (31.70)	1.156 (23.96)	1.453 (36.91)	.120 (3.05)	.556 (14.12)	.094 (2.39)
22	1.373 (34.87)	1.250 (31.75)	1.578 (40.08)	.120 (3.05)	.556 (14.12)	.094 (2.39)
24	1.498 (38.05)	1.375 (34.93)	1.703 (43.26)	.147 (3.73)	.589 (14.96)	.094 (2.39)

Protective Caps

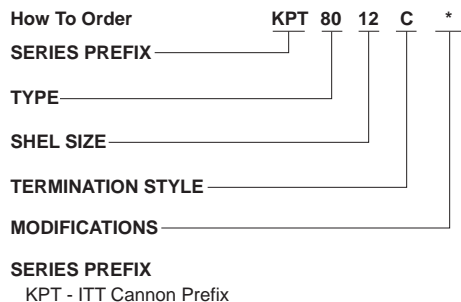

80 - cap for plugs

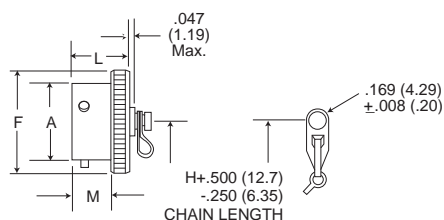

81 - cap for receptacle

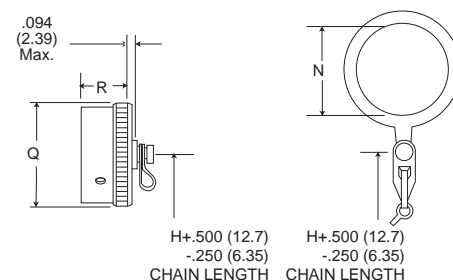

TYPE
80 - Plug Cap
81 - Receptacle Cap

SHELL SIZE
8 thru 24

TERMINATION STYLE
C - Sash Chain
N - Sash Chain with Ring (81 type only)

NOTE: For MS version and additional finishes see PV catalog.
(N Style use Primarily for Jam Nut Receptacle)

Shell Size	A ± .003 (.08)	F Max.	H	L Max.	M +.031 (.79) -.000 (.00)	N Min.	Q Max.	R Max.
8	.471 (11.96)	.719 (18.26)	3.000 (76.20)	.562 (14.27)	.368 (9.35)	.578 (14.68)	.734 (18.64)	.562 (14.27)
10	.588 (14.94)	.844 (21.44)	3.000 (76.20)	.562 (14.27)	.368 (9.35)	.703 (17.86)	.859 (21.82)	.562 (14.27)
12	.748 (19.00)	1.000 (25.40)	3.500 (88.90)	.562 (14.27)	.368 (9.35)	.891 (22.63)	1.000 (24.40)	.562 (14.27)
14	.873 (22.17)	1.125 (28.58)	3.500 (88.90)	.562 (14.27)	.368 (9.35)	1.016 (25.81)	1.125 (28.58)	.562 (14.27)
16	.998 (25.35)	1.250 (31.75)	3.500 (88.90)	.562 (14.27)	.368 (9.35)	1.141 (28.98)	1.250 (31.75)	.562 (14.27)
18	1.123 (28.52)	1.375 (34.93)	3.500 (88.90)	.562 (14.27)	.368 (9.35)	1.266 (32.16)	1.375 (34.93)	.562 (14.27)
20	1.248 (31.70)	1.500 (38.10)	4.000 (101.60)	.625 (15.88)	.430 (10.92)	1.391 (35.33)	1.500 (38.10)	.562 (14.27)
22	1.373 (34.87)	1.625 (41.26)	4.000 (101.60)	.625 (15.88)	.430 (10.92)	1.516 (38.51)	1.625 (41.26)	.562 (14.27)
24	1.498 (38.05)	1.750 (44.45)	4.000 (101.60)	.658 (16.71)	.463 (11.76)	1.641 (41.68)	1.750 (44.45)	.602 (15.29)

MATERIALS AND FINISHES

KPT	
Protective Cap	aluminum alloy, olive drab finish per QQ-P-416
Sash Chain	stainless steel
Ring/Rivet	stainless steel
Gasket	polychloroprene

MIL-C-26482 Specifications

The following excerpts are some of the parameter requirements of the MIL-C-26482 specification.

Test Description	Paragraph Reference	Requirements																																						
Contact Retention	4.6.32.1	After preloading to 3 pounds maximum, the force shall be applied at a rate of approximately 1 pound per second and maintained at full load for 5-10 seconds. No damage to contacts or insert shall result nor shall the contacts be dislocated from their normal position in the connector more than 0.012 inch under give-load for KPSE and within 1 minute after the load is removed for KPT.																																						
		<table border="1"> <thead> <tr> <th>Contact Size</th> <th>20</th> <th>16</th> <th>12</th> </tr> </thead> <tbody> <tr> <td>Load in Pounds Min.</td> <td>15</td> <td>25</td> <td>25</td> </tr> </tbody> </table>	Contact Size	20	16	12	Load in Pounds Min.	15	25	25																														
Contact Size	20	16	12																																					
Load in Pounds Min.	15	25	25																																					
Contact Insertion/Extraction (KPSE only)	4.6.11	When using the proper insertion and extraction tools the forces required to insert or extract the contact shall not exceed 20 lbs. Connectors shall be less endbell.																																						
Coupling Torque	4.6.3	For qualification testing, mating halves shall be coupled and uncoupled, measuring the torques necessary. The torques required to couple and uncouple mating connectors halves shall fall within the limits specified as follows:																																						
		<table border="1"> <thead> <tr> <th rowspan="2">Shell Size</th> <th colspan="2">Torque lb./in.</th> <th rowspan="2">Shell Size</th> <th colspan="2">Torque lb./in.</th> </tr> <tr> <th>Max.</th> <th>Min.</th> <th>Max.</th> <th>Min.</th> </tr> </thead> <tbody> <tr> <td>8</td> <td>8</td> <td>1</td> <td>18</td> <td>28</td> <td>4</td> </tr> <tr> <td>10</td> <td>12</td> <td>1</td> <td>20</td> <td>32</td> <td>6</td> </tr> <tr> <td>12</td> <td>16</td> <td>2</td> <td>22</td> <td>36</td> <td>7</td> </tr> <tr> <td>14</td> <td>20</td> <td>4</td> <td>24</td> <td>44</td> <td>7</td> </tr> <tr> <td>16</td> <td>24</td> <td>4</td> <td></td> <td></td> <td></td> </tr> </tbody> </table>	Shell Size	Torque lb./in.		Shell Size	Torque lb./in.		Max.	Min.	Max.	Min.	8	8	1	18	28	4	10	12	1	20	32	6	12	16	2	22	36	7	14	20	4	24	44	7	16	24	4	
Shell Size	Torque lb./in.			Shell Size	Torque lb./in.																																			
	Max.	Min.	Max.		Min.																																			
8	8	1	18	28	4																																			
10	12	1	20	32	6																																			
12	16	2	22	36	7																																			
14	20	4	24	44	7																																			
16	24	4																																						
Durability	4.6.17	Connector halves shall be mated and unmated 500 times at a rate of 200 ± 100 cycles per hour. The test may be performed by hand or by mechanical means, but the coupling ring shall be operated as in normal service. Failure to complete this test because of mechanical malfunction shall be cause for rejection.																																						
Insert Retention	4.6.29	Connectors with the endbells and grommets (if possible) removed shall be subjected to a 75 psi load on the insulator in both directions. The load shall be applied at a rate of 10lb/sec. and held for 5 to 10 secs. Insulators shall not be dislogged from their original position.																																						
Insulation Resistance	4.6.7.1	On unmated connectors at 25°C±3°C a potential of 500 VDC ± 10% shall be applied between all, but not more than 6, pairs of adjacent contacts and between all, but not more than 6, contacts and the shell. Failure to meet a minimum requirement of 5,000 megohms shall be cause for rejection.																																						
Vibration	4.6.21	Wired, mated connectors shall be subjected to the vibration test of MIL-STD-1344, Method 2005, Test Condition II. Receptacles shall be mounted on the vibration fixture by normal means. All contacts shall be wired in a series circuit and 100 max. milliamperes of current shall be allowed to flow through the series circuit during vibration. Suitable means shall be employed to monitor the current flow and to indicate any discontinuity of more than 10 microseconds. The wire bundle shall be clamped to nonvibrating points at least 8 inches from the rear of the connector. Current discontinuity of 10 microsecond or more, disengagement of the mated connectors, evidence of cracking, breaking, or loosening of parts shall be cause for rejection.																																						
Shock	4.6.23	Wired, mated connectors shall be subjected to one shock in each direction in each of three mutually perpendicular axes. The pulse shall be approximate half sine wave of 50g±15% magnitude with a duration of 11 ± 1 milliseconds. Receptacles shall be mounted on a shock fixture by normal means. All contacts shall be wired in a series circuit and 90-110 ma, of current shall flow through the series circuit during shock. Suitable means shall be employed to Monitor the current flow and to indicate any discontinuity of more than 10 microseconds. Current discontinuity of 10 microseconds or more, disengagement of the mated connectors, evidence of cracking, breaking, or loosening of parts shall be cause for rejection.																																						
Thermal Shock	4.6.12	Wired, unmated plug and receptacle shall be subjected to 5 cycles of hot and cold temperatures. Maximum temperature shall be + 125°C and the minimum shall be -55°C. Duration at each temperature extreme shall be 1/2 hour minimum. Cracking, breaking or loosening of parts shall be cause for rejection.																																						
Humidity	4.6.25	The connectors shall be subjected to varying humidity, 50% to 95%, conditions for a period of 10 days KPSE or 20 days KPT. The insulation resistance shall not be less than 100 megohms.																																						
Air Leakage (KPT Only)	4.6.15.1	A 30 psi pressure differential shall be applied across the connector for 30 minutes. The leak rate, in either direction, shall be no greater than 1 atmosphere cubic inch per hour (4.55 X 10 ⁻⁶ cm ³ /S) at - 67°F (- 55°C).																																						
Salt Spray (Corrosion)	4.6.19	Unmated and wired connectors shall be subject to a salt fog for 48 hours. These shall be no exposure of base metal, the connector shall be functional and meet the contact resistance requirement.																																						
Fluid Immersion	4.6.27	At least one connector, unmated and wired, shall be immersed in each fluid for a period of 20 hours then dried at room conditions for hour. Connectors shall be able to mate and meet the coupling torque requirements. a) Hydraulic Fluid per MIL-H-5606, b) Lubricating Oil per MIL-L-7808																																						

Tooling, Crimp

M22520/1-01 CRIMP TOOL
M22520/1-02 Turret

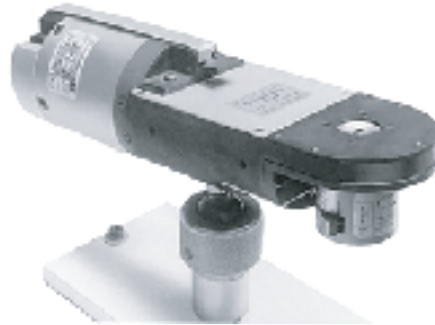

CBT-520/530

Tooling, Insertion/Extraction



KPSE Insertion



KPSE Extraction

Contact Size	
20	MS24256A20
16	MS24256A16

Contact Size	
20	MS24256R20
16	MS24256R16

Contacts

Contact Size/Type	Military Part Number	Color Bands			ITT Cannon Part Number
		1st	2nd	3rd	
20 Socket	M39029/32-259	Red	Green	White	031-9074-002
20 Pin	M39029/31-240	Red	Yellow	Black	030-9036-000
16 Socket	M39029/32-247	Red	Yellow	Violet	031-9095-003
16 Pin	M39029/31-228	Red	Red	Grey	030-9032-003

#20

Contacts for printed circuit applicaitons also available

Wire Hole Fillers/Grommets Sealing Plugs

Contact Size	Part Number		Color Code
	Cannon	Military	
20	225-1012-000	MS3187A20	Red
16	225-1011-000	MS3187-16	Blue

KPSE Assembly Instructions

Contact Size	Wire Size AWG	Strip Insulation
20	#20-#24	3/16"
16	#16-#20	1/4"

Right

Wrong



CRIMPING CONTACTS

1. Strip wires according to the table above taking care not to cut or nick strand.

2. Insert stripped wire into contact crimp pot. Wire must be visible thru inspection hole.

3. Using correct crimp tool and locator select proper crimp setting for wire size to be crimped; cycle the tool once to be sure the indentors are open. Insert contact and wire into locator. Squeeze tool handles firmly and completely to insure a proper crimp. The tool will not release unless the crimp indentors in the tool head have been fully actuated. Release crimped contact and wire from tool. Be certain the wire is visible thru inspection hole in contact.

CAUTION: Check that none of the contacts are bent or damaged in any way after crimping.

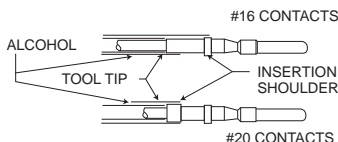
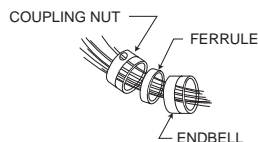

CONTACT INSERTION

1. Remove hardware from plug and receptacle. Slide hardware over wire bundle in proper order for reassembly.

2. Use the proper contact insertion tool and slide the tool over the terminal end of the contact. The size 16 contact lies in the tool and the tool tip butts against the contact shoulder. The rear, or insulation support of the size 20 contact butts against an internal shoulder in the tool tip.

NOTE: Apply a small amount of isopropyl alcohol to the insertion tool tip while installing contacts.

3. Beginning from center cavity and working outwards in a circular pattern, insert wired contacts into rear of connector by hand until the front of the contact shoulder is no more than 1/8" from the grommet. Holding the connector horizontally, position tool behind contact. Push tool straight into contact cavity until contact snaps into position. A light pull on wire will assure that contact is locked securely. Repeat for remaining contacts.

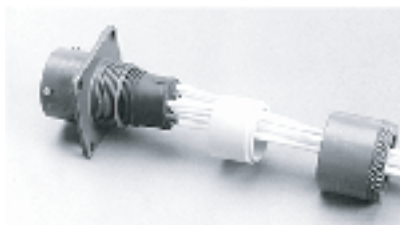

Size	Torque in/lbs.
8,10,12 and 14	10-15
16 and 18	15-25
20,22 and 24	25-35

4. Use contacts and grommet sealing plugs to fill any empty cavities.

COMPLETION

1. Check face of plug or receptacle for proper contact installation.

2. Using mating connector with contacts installed, mate both connector halves together.

3. Assemble ferrule over the grommet by hand as far as possible.

4. Assemble endbell over ferrule and loosely tighten endbell. Partially loosen (1/4 turn) and retighten to recommended torque limits.



2nd Index Line
Socket Contacts

1st Index Line
Pin Contacts



CONTACT EXTRACTION

1. Slide hardware back over wire bundle. Using proper extraction tool or extraction end of proper insertion/extraction tool, proceed as follows:

KPSE: There are two lines on the clip sleeve which are vital to the contact removal process. The first index line is used for removing pin contacts while the second index line is for removing socket contacts.

Carefully place the tool tip over the contact to be extracted until the tool tip touches the insulator face. Carefully rotate the tool until the index line is slightly below the insulator face. Keep an even pressure against tool body; push plunger forward with thumb and index finger, and push the contact out through the clip. Carefully remove extraction tool from connector. Pull wire by hand to complete the removal of the contact.

How to Order - Special Termination Connectors



KPT	03	-	18	-	32	P	W
KPT	04	-	18	-	32	P	W
KPT	05	-	18	-	32	P	W
KPSE	03	-	18	-	32	P	W
KPSE	04	-	18	-	32	P	W
KPSE	05	-	18	-	32	P	W

PREFIX _____

SHELL STYLE _____

DASH (No Class required, less rear termination) _____

SHELL SIZE _____

CONTACT ARRANGEMENT _____

CONTACT TYPE _____

P - PIN

S - Socket

ALTERNATE INSERT POSITION _____

Contact ITT Cannon for additional Information

Solder Type KPT03/04/05-Supplied less endbell, ferrule and grommet.

KPT03

KPT04



KPT05



Solder Type KPSE03/04/05-Supplied less endbell, ferrule.

KPSE03



KPSE04

KPSE05



Twist Pull Lanyard Release Coupler Plug

KPT06/KPSE06



KPT	6	A	22	-	55	P	W	16
KPSE	6	E	22	-	55	S	Z	16

PREFIX _____

SHELL STYLE _____

SERVICE TYPE _____

SHELL SIZE _____

CONTACT ARRANGEMENT _____

CONTACT TYPE _____

POLARIZATION _____

MODIFICATION CODE* _____

*Omit (0) of shell style indication when using this modification code.

16 = Overall length of connector including lanyard to be 6.0 (152.40) ± .125 (3.18) when measured over a 1.0 (25.40) ± .005 (0.13) diameter mandrel.

Printed Circuit Termination

KPT02E



KPT07

