

Features

- Low profile 4.0mm
- Low cost
- Wide input range (5V - 36V)
- Short circuit protection
- Casellated connections

ROF-78E

Non Isolated Power Module



Description

The ROF-78E is a switching regulator with a wide input voltage range, high efficiency and a low profile, pin-less SMD package. Two low-ripple output voltages are available as standard: 3.3V or 5V with 500mA continuous output current rating over the full operating temperature range of -40°C to +75°C without derating. An enable connection allows power sequencing or very low standby consumption (3.5µA) for battery powered applications. These modules can be SMD reflow soldered. The connection pads have corner half-vias to enable optical inspection of the joints after soldering.

Selection Guide

Part Number	Input Voltage Range [VDC]	Output Voltage [VDC]	Output Current [mA]	Efficiency typ. [%]
ROF-78E3.3-0.5SMD-R	5 - 36	3.3	500	73 - 84
ROF-78E5.0-0.5SMD-R	9 - 36	5.0	500	79 - 87

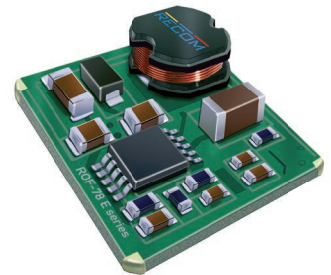

Model Numbering

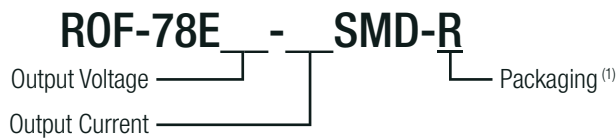

Notes:

Note1: suffix -R for tape&reel packaging

Ordering Examples:

ROF-78E3.3-0.5SMD-R = 3.3Vout, 0.5A Output Current, SMD, tape and reel packaging

Specifications (measured @ Ta= 25°C, nom. Vin, full load and after warm-up unless otherwise stated)

BASIC CHARACTERISTICS

Parameter	Condition		Min.	Typ.	Max.
Input Voltage Range	nom. Vin= 12VDC and 24VDC		5VDC		36VDC
Input Current					500mA
Quiescent Current					5mA
Minimum Load ⁽²⁾			10%		
ON/OFF CTRL	max. Vin= 5VDC	DC-DC ON DC-DC OFF			Open or >1.75VDC GND or <0.7VDC
Standby Current	DC-DC OFF			3.5µA	6.5µA
Internal Operating Frequency				650kHz	
Output Ripple and Noise	20MHz BW				100mVp-p

ROF-78E3.3-0.5SMD

Efficiency vs. Load

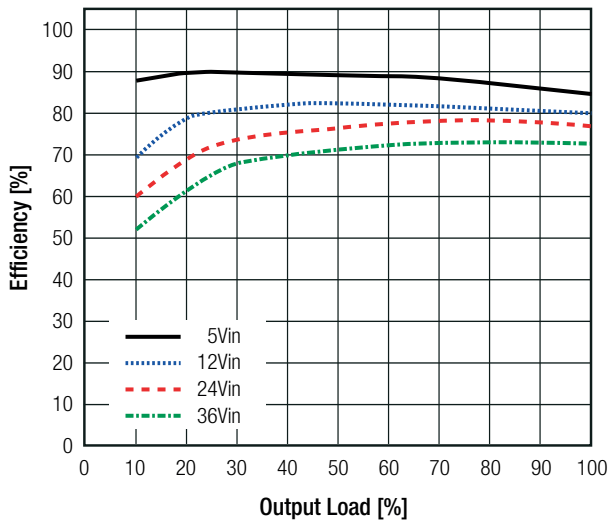

Ripple vs. Load

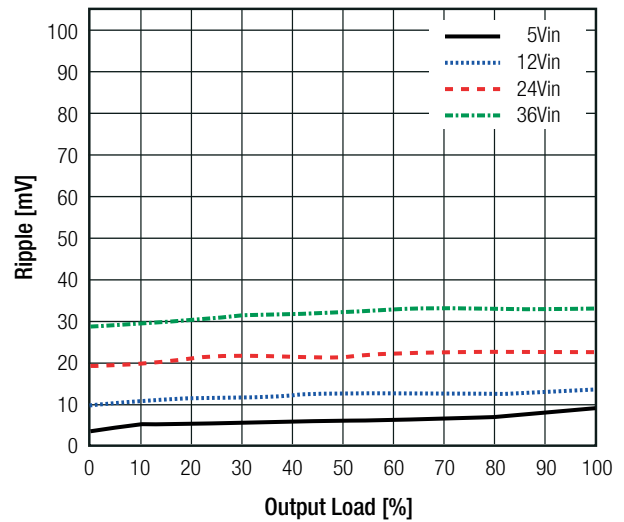

ROF-78E5.0-0.5SMD

Efficiency vs. Load

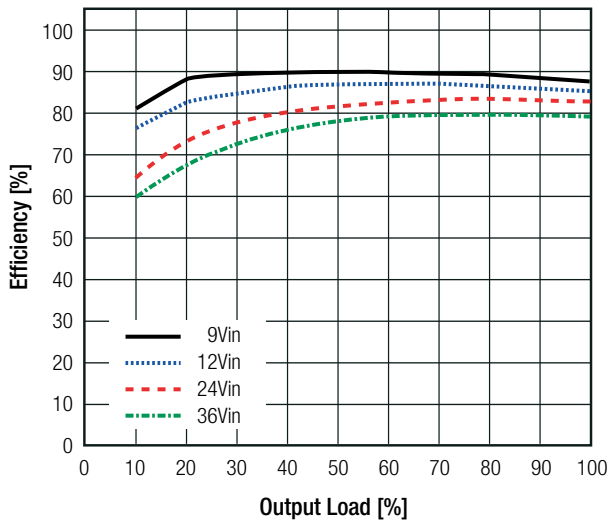

Ripple vs. Load

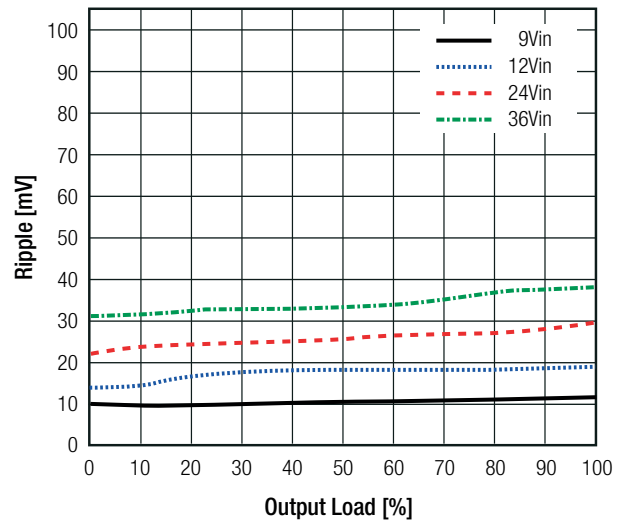

Specifications (measured @ Ta= 25°C, nom. Vin, full load and after warm-up unless otherwise stated)

REGULATIONS		
Parameter	Condition	Value
Output Accuracy		±5.0% max.
Line Regulation	low line to high line	±1.0% max.
Load Regulation ⁽²⁾	10% to 100% load	± 3.0% typ.
Transient Response	100% to 50% load	±100mV
	100% to 10% load	±200mV

Notes:
Note2: Operation below 10% load will not harm the converter, but specifications may not be met

PROTECTIONS		
Parameter	Condition	Value
Short Circuit Protection (SCP)		automatic recovery
Short Circuit Input Current		200mA max.
Over Current Protection (OCP)		>950mA typ. Hiccup mode

Optional Diode Protection Circuit

Add a blocking diode to Vout if current can flow backwards into the output, as this can damage the converter when it is powered down.

The diode can either be fitted across the device if the source is low impedance or fitted in series with the output (recommended).

Optional Protection 1:

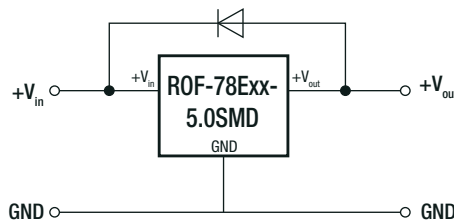

Optional Protection 2:

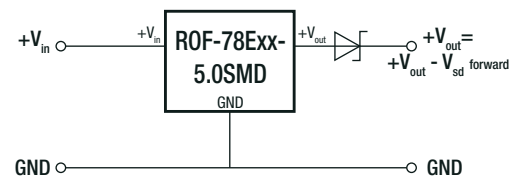

ENVIRONMENTAL		
Parameter	Condition	Value
Operating Temperature Range	with derating @ free air convection (see graph)	-40°C to +85°C
Operating Humidity	non-condensing	5% - 95% RH max.
MTBF	according to MIL-HDBK-217F, G.B.	+25°C 3500 x 10 ³ hours

Derating Graph
(@ free air convection)

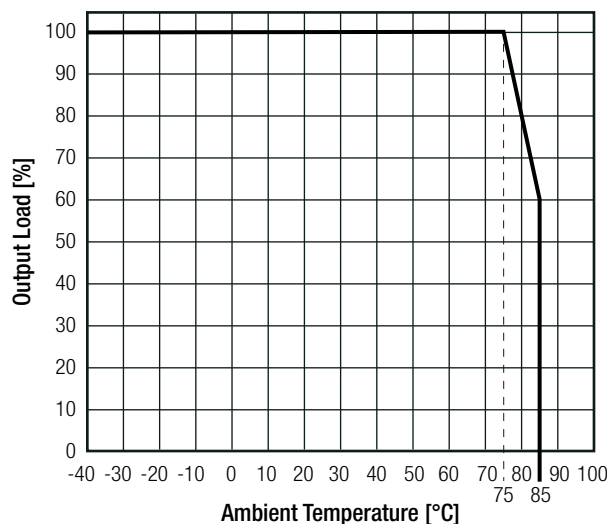

Specifications (measured @ Ta= 25°C, nom. Vin, full load and after warm-up unless otherwise stated)

SAFETY AND CERTIFICATIONS

Certificate Type (Safety)	Report / File Number	Standard
RoHS 2+		RoHS-2011/65/EU + AM-2015/863
EAC	RU-AT.49.09571	TP TC 004/2011

EMC Compliance

EMC Compliance	Condition	Standard / Criterion
Information technology equipment - Radio disturbance characteristics - Limits and methods of measurement	with external filter	EN55032, Class B

EMC Filtering Suggestion according to EN55032 Class A and Class B

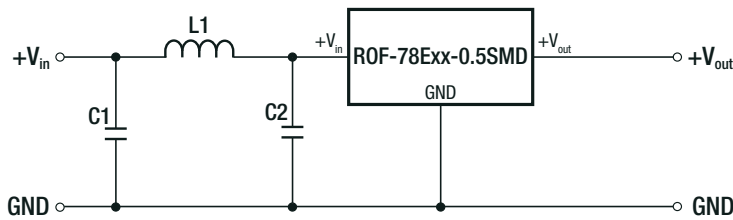

Component List Class A and B

C1	C2	L1
1µF	1µF	33µH

The capacitors used are ceramic capacitors, rated voltage 50V

DIMENSION AND PHYSICAL CHARACTERISTICS

Parameter	Type	Value
Material	PCB	FR4, (UL94 V-0)
Package Dimension (LxWxH)		12.5 x 13.5 x 4.0mm
Package Weight		1g typ.

Dimension Drawing (mm)

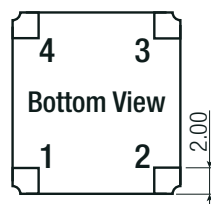
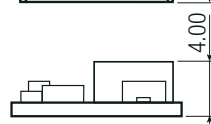
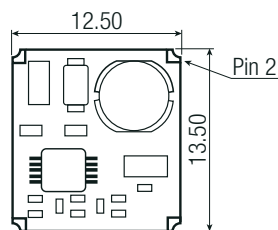

Recommended Footprint Details

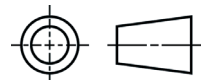
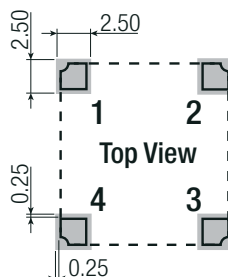

Pin Connections

Pin #	Single
1	+Vin
2	GND
3	+Vout
4	CTRL

Tolerance: xx.xx= ±0.25mm

Specifications (measured @ Ta= 25°C, nom. Vin, full load and after warm-up unless otherwise stated)

INSTALLATION AND APPLICATION

Standard Application Circuit

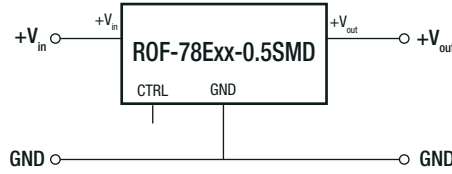

Application Examples

High Efficiency, Isolated, Dual Unregulated Output

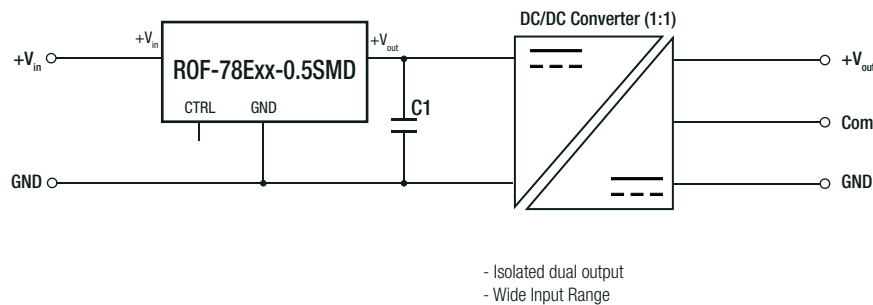

Isolated (up to 6kVDC), Wide Input Range Regulated Output

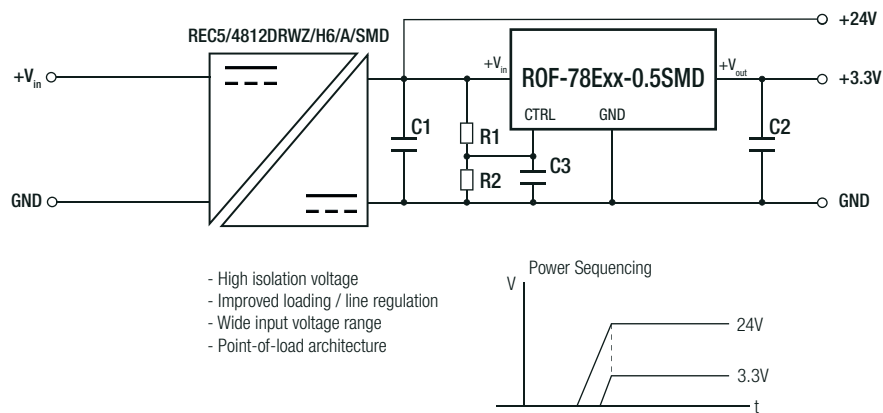

PACKAGING INFORMATION

Parameter	Type	Value
Packaging Dimension (LxWxH)	tape and reel (carton)	355.0 x 342.0 x 36.0mm
Packaging Quantity	tape and reel	500pcs
Tape Width		24mm
Storage Temperature Range		-55°C to +125°C
Storage Humidity		95% RH max.

The product information and specifications may be subject to changes even without prior written notice. The product has been designed for various applications; its suitability lies in the responsibility of each customer. The products are not authorized for use in safety-critical applications without RECOM's explicit written consent. A safety-critical application is an application where a failure may reasonably be expected to endanger or cause loss of life, inflict bodily harm or damage property. The applicant shall indemnify and hold harmless RECOM, its affiliated companies and its representatives against any damage claims in connection with the unauthorized use of RECOM products in such safety-critical applications.