

1. Emitter 2. Collector 3. Base
 TO-92 Plastic Package



Features

- ◇ For switching and AF amplifier applications
- ◇ These types are subdivided into three groups -16, -25 and -40, according to their DC current gain
- ◇ Moisture sensitivity level 1
- ◇ Driver transistor
- ◇ Pb free version and RoHS compliant
- ◇ Green compound (Halogen free) with suffix "G" on packing code and prefix "G" on date code

Mechanical Data

- ◇ Case : TO-92 small outline plastic package per MIL-STD-202, Method 208 guaranteed
- ◇ High temperature soldering guaranteed: 260°C/10s
- ◇ Weight approx.: 190 mg

Ordering Information (example)

Part No.	Package	Packing	Packing code	Packing code (Green)	Marking	Manufacture code
BC337-16/25/40	TO-92	4K / AMMO	A1	A1G	BC337-16/25/40	B0

Note : Detail please see "Ordering Information(detail, example)" below.

Maximum Ratings and Electrical Characteristics

Rating at 25 °C ambient temperature unless otherwise specified.

Parameter	Symbol	BC337	BC338	Units
Collector Base Voltage	V_{CBO}	50	30	V
Collector Emitter Voltage	V_{CEO}	45	25	V
Emitter Base Voltage	V_{EBO}	5		V
Collector Current	I_C	800		mA
Peak Collector Current	I_{CM}	1		A
Total Power Dissipation	P_{TOT}	625		mW
Junction Temperature	T_J	150		°C
Storage Temperature Range	T_{STG}	- 55 to + 150		°C

Parameter	Symbol	Min.	Typ.	Max.	Units
DC Current Gain at $V_{CE}=1V, I_C=100mA$ Current Gain Group -16 -25 -40 at $V_{CE}=1V, I_C=300mA$	h_{FE}	100	-	250	V
		160	-	400	
		250	-	630	
		60	-	-	
Collector Base Cutoff Current at $V_{CB}=50V$ at $V_{CB}=30V$	I_{CBO}	-	-	100	nA
		-	-	100	
Collector Base Breakdown Voltage at $I_C=100\mu A$	$V_{(BR)CBO}$	50	-	-	V
		30	-	-	
Collector Emitter Breakdown Voltage at $I_C=2mA$	$V_{(BR)CEO}$	45	-	-	V
		25	-	-	
Emitter Base Breakdown Voltage at $I_E=100\mu A$	$V_{(BR)EBO}$	5	-	-	V
Collector Emitter Saturation Voltage at $I_C=500mA, I_B=50mA$	$V_{CE(sat)}$	-	-	0.7	V
Base Emitter On Voltage at $V_{CE}=1V, I_C=300mA$	$V_{BE(on)}$	-	-	1.2	V
Transition Frequency at $V_{CE}=5V, I_C=10mA, f=50MHz$	f_T	-	100	-	MHz
Output Capacitance at $V_{CB}=10V, f=1MHz$	C_{ob}	-	12	-	pF

Small Signal Product

FIG.1 STATIC CHARACTERISTIC

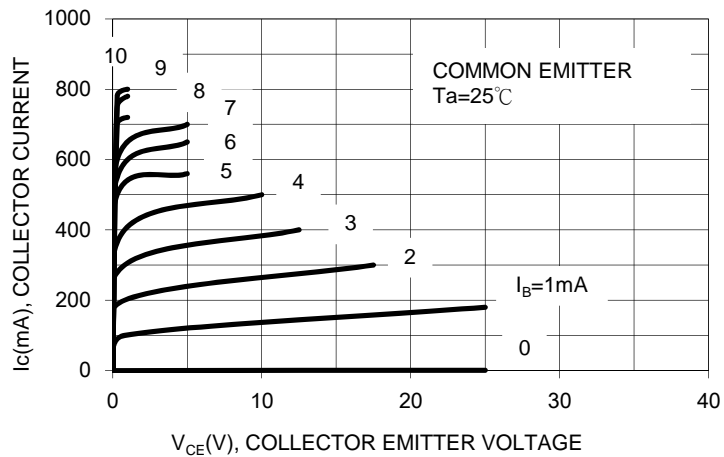

FIG.2 STATIC CHARACTERISTIC

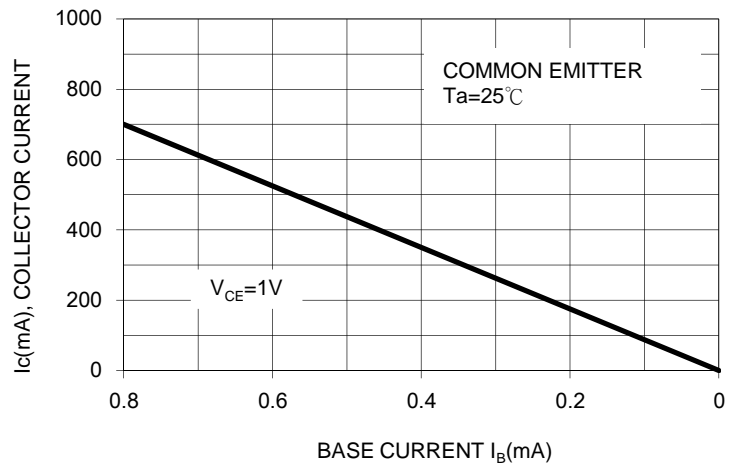

FIG.3 STATIC CHARACTERISTIC

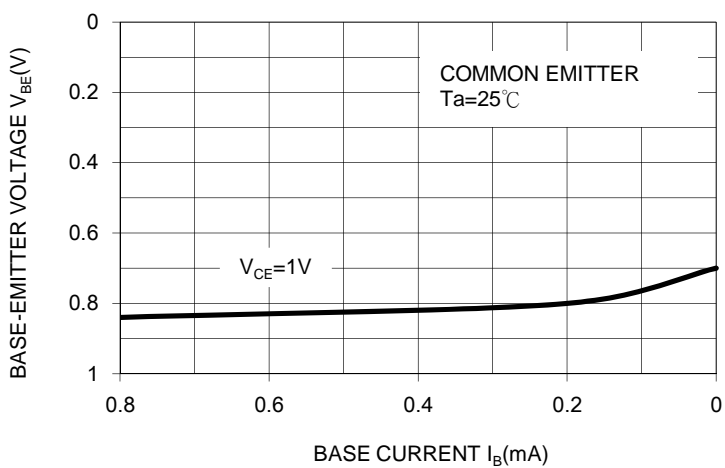

FIG. 4 $h_{FE} - I_C$

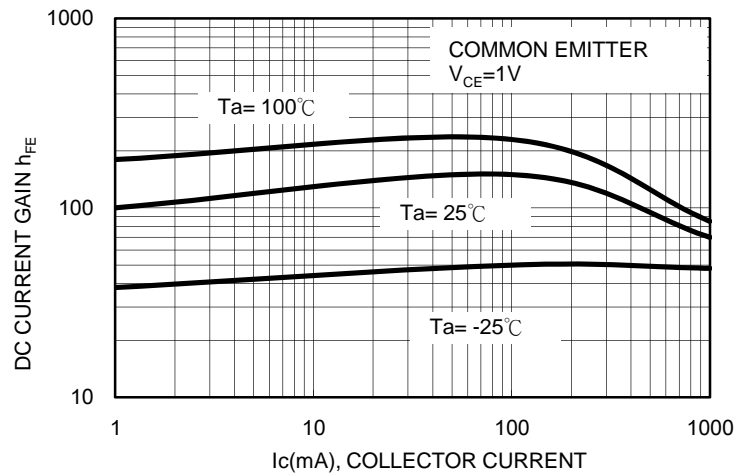

FIG.5 $I_C - V_{CE}$ (LOW VOLTAGE REGION)

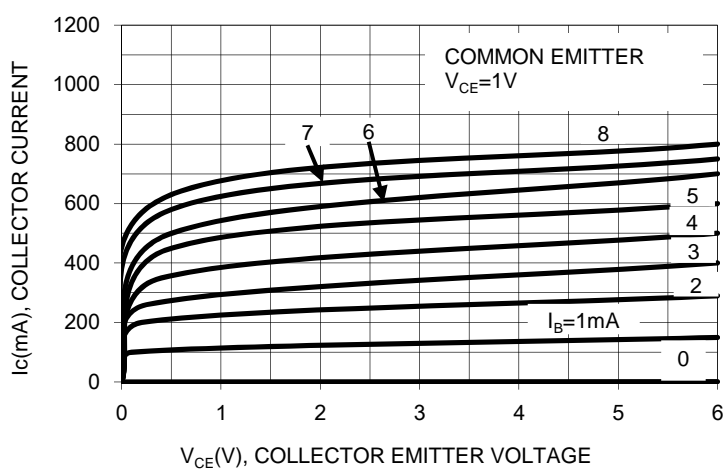
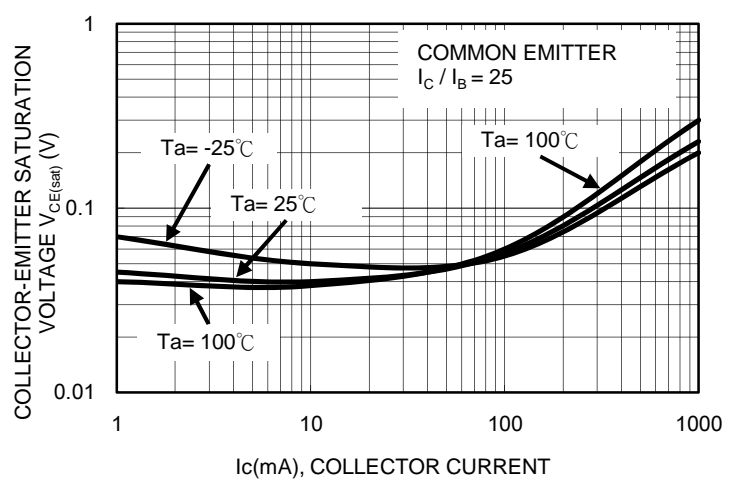

FIG. 6 $V_{CE(sat)} - I_C$



Small Signal Product

FIG.7 $I_C - V_{BE}$

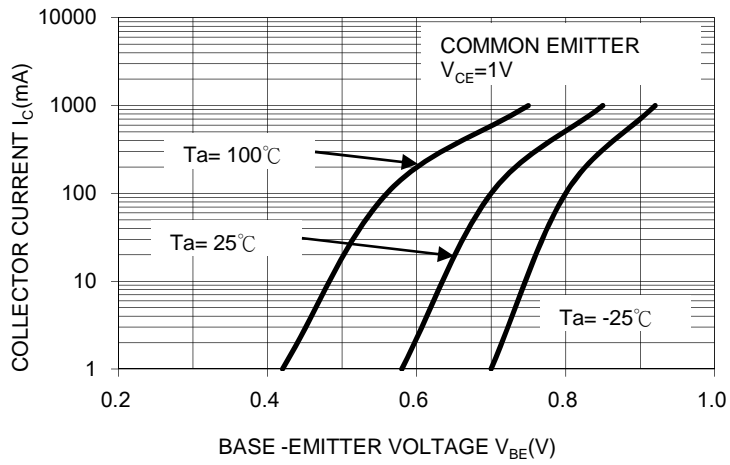

FIG.8 $f_T - I_C$

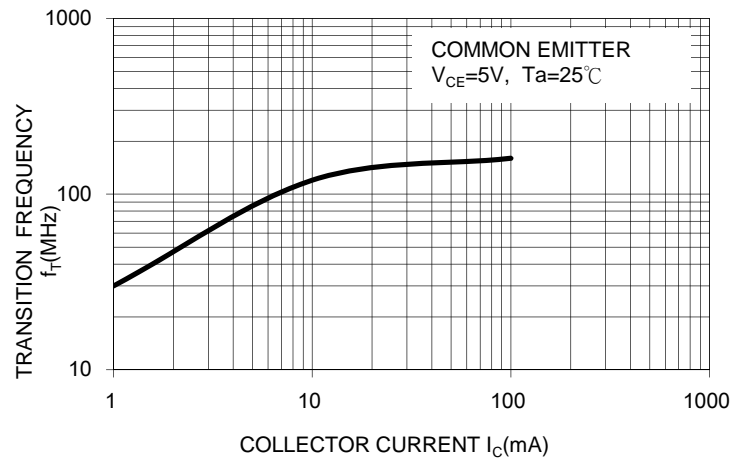
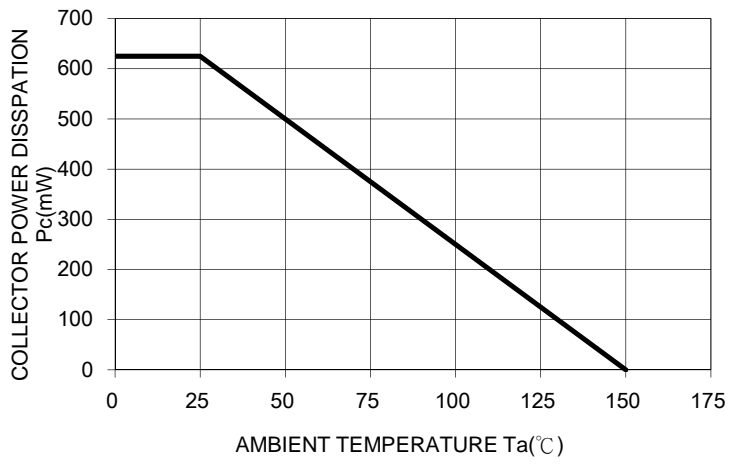

FIG.9 $P_c - T_a$



Ordering information (detail, example)

Part No.	Package	Packing	Packing code	Packing code (Green)	Marking	Manufacture code
BC33x-16/25/40 (Note1)	TO-92	4K / Ammo	A1	A1G	BC33x-16/25/40 (Note1)	(Note 2)
		5K / Bulk	B1	B1G		
BC337-16/25/40	TO-92	4K / Ammo	A1	A1G	BC337-16/25/40	
BC337-16/25/40	TO-92	4K / Ammo	A1	A1G	BC337-16/25/40	B0

Note 1: "x" is Device Code from "7" thru "8".

Note 2: Manufacture special control, if empty means no special control requirement.

Small Signal Product

Bulk Packing Dimensions

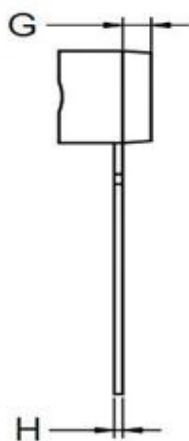
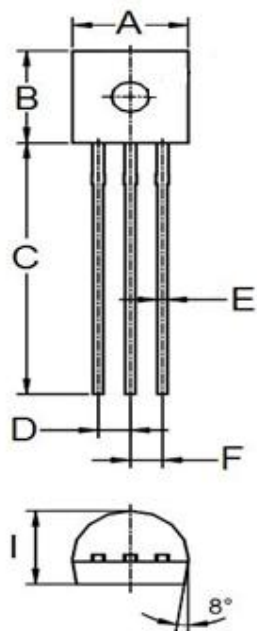

DIM.	Unit(mm)		Unit(inch)	
	Min	Max	Min	Max
A	4.40	5.10	0.173	0.201
B	4.30	4.70	0.169	0.185
C	12.50	-	0.492	-
D	1.17	1.37	0.046	0.054
E	0.350	0.550	0.014	0.022
F	1.17	1.37	0.046	0.054
G	1.00	1.40	0.039	0.055
H	0.29	0.51	0.011	0.020
I	3.30	4.10	0.130	0.161

AMMO Packing Dimensions

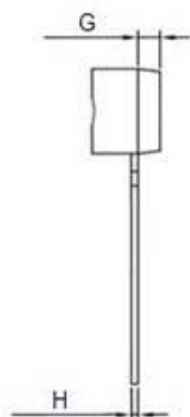
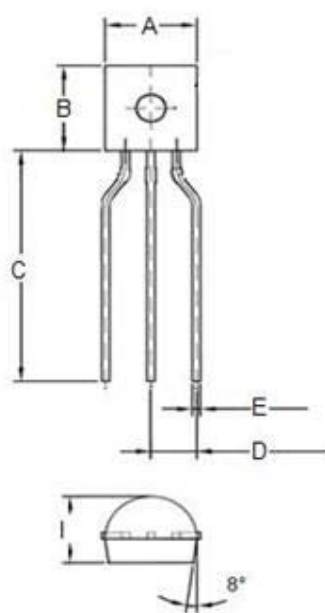

DIM.	Unit(mm)		Unit(inch)	
	Min	Max	Min	Max
A	4.30	5.10	0.169	0.201
B	4.30	4.70	0.169	0.185
C	12.50	-	0.492	-
D	2.20	2.80	0.087	0.110
E	0.350	0.550	0.014	0.022
G	1.00	1.40	0.039	0.055
H	0.29	0.51	0.011	0.020
I	3.40	4.10	0.134	0.161